

REAL DEALS

PRICES VALID APRIL 1 – JUNE 30, 2024

PORTACOOOL®

PEAK COOLING, INTELLIGENT CONTROL



THE APEX SERIES

TAKING EVAPORATIVE COOLING TECHNOLOGY TO NEW HEIGHTS



TECHNOLOGY

Wi-Fi Connectivity
Control from anywhere
Powered by CoolSync™ Tech



PERFORMANCE

Extended cooling up to 60 ft
Whisper-quiet performance
Smart water management

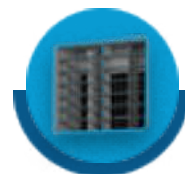

DESIGN

Tough-coat texture housing
Unmatched portability
Space optimization



COOLSYNC™ TECHNOLOGY

Sync your cooler to your smartphone
Take total control from anywhere

CONTENTS

A/C SERVICE	4
AIR & POWER TOOLS.....	10-13
CHARGING STARTING & TESTING	14-15
CLEARANCE	31

DIAGNOSTIC.....	16-19
HOT BUYS	3
HAND & SERVICE TOOLS	6-9
NEW AT NAPA	2

SHOP COOLING.....	5
SHOP EQUIPMENT.....	22-28
TOOL STORAGE & ORGANIZATION.....	20-21
WELDING	29-30



\$110 for 12 mos.

\$1099

COMPACT 1.7 GPM, 2000 PSI, 110V ELECTRIC COLD WATER PRESSURE WASHER

BK GT219CSE DS



\$369

DEWALT 20V MAX* XR® BRUSHLESS CORDLESS 1/2IN HIGH TORQUE WRENCH WITH HOG RING ANVIL (TOOL ONLY)

DEW DCF961B DS



\$229

DEWALT 20V MAX* XR® BRUSHLESS 3/8IN & 1/2IN SEALED HEAD RATCHET (TOOL ONLY)

DEW DCF510B DS



\$299

MILWAUKEE® M12™ INSIDER™ EXTENDED REACH BOX RATCHET (TOOL ONLY)

MIL 305020 DS



\$249

MILWAUKEE® M18™ BRUSHLESS 18" FAN

MIL 082120 DS



\$429

MILWAUKEE® M12™ AUTO TECHNICIAN BORESCOPE

MIL 315020



\$240 for 60 mos.

\$10800

CHALLENGER LIFTS 3300 LB. ELECTRIC VEHICLE BATTERY LIFT TABLE

- MAX LIFT HEIGHT 76.5 INCHES
- EXTENDING, ADJUSTING AND TILTING TOP PLATE
- 120 VOLT

CL BT3300 DS



\$649

SCHUMACHER LEVEL 2 EV WALL CHARGER

NBC SEV1600HW DS Hardwired 240V 50A
NBC SEV1600P1450 DS NEMA 14-50 240V 40A



\$141 for 12 mos.

\$1400

AUTEL® MAXIFLASH 3 IN 1 COMMUNICATION AND PROGRAMMING DEVICE

ATD XLINK DS

*DS = Special Order Item. Contact NAPA representative for lead time





Was ~~\$155.99~~
Now **\$109**

35 pc. Impact Bit Set
CHT IBS35



CHT PSLNPG3 3 pc. Long Nose Pistol Grip Pliers Set
CHT PSA3 3 pc. Pliers Set

Was ~~\$146.99~~ Now **\$105**
Was ~~\$102.99~~ Now **\$93.49**



Carlyle® Every Day Carry Knives

• MAX-LOCK™ technology secures the blade in open and closed position

CHT FK28EDCBL Blue 2.8" Was ~~\$49.99~~ Now **\$34.99**
CHT FK32EDCBL Blue 3.2 in. Was ~~\$34.99~~ Now **\$24.49**

Was ~~\$124~~
Now **\$74.99**

SOR CBC612V10A
6/12V Battery Charger

- 10/6/2A
- Power Supply Mode
- Able to charge 0.0V batteries
- Charges Flooded, AGM, Spiral and LiFePO4 batteries

SOR CBC612V10A

10 AMP



SOR CJS12V600A
12 VOLT JUMP STARTER

Was ~~\$589~~
Now **\$249**

- 2000 Peak Amps
- 46" #2 Gauge Cables
- Automatic Built-In Charger

SOR CJS12V600A

600A CRANKING AMPS



Was ~~\$81.99~~
Now **\$57.49**

Carlyle® Mini Bolt Cutters
8 in.
CHT MBC8



Was ~~\$163.99~~
Now **\$149**

Combination End Wrench Set
11 pc.SAE
CHT CW1211



Was ~~\$147.99~~
Now **\$105**

7 Pc. ANGLE WRENCH SET, SAE
CHT ADOW8



Was ~~\$59.99~~
Now **\$41.99**

Carlyle® 2.8 in. Wild MAX
Black
CHT FK28WMBK



SER 70801⁹⁹ Cing Sys Pwr Fish Gun
SER 80031 TestVac Brake Bleeding Kit Vacuum Pump
SER 70880⁹⁹ Cing Sys Refilling Gun
SER 71800 QuickFlow Brake Bleeder

Was ~~\$72.99~~ Now **\$51.99**
Was ~~\$70.99~~ Now **\$63.99**
Was ~~\$218.99~~ Now **\$155**
Was ~~\$310.99~~ Now **\$219**



Was ~~\$141.99~~
Now **\$99.49**

Carlyle® 3 pc. Wire Stripper Set
CHT PSW3



Was ~~\$52.99~~
Now **\$36.99**

Carlyle® 17-in-1 Multi Tool
CHT MT17



SOR JNC345
LITHIUM 12 VOLT JUMP STARTER

- 550 Start Assist Amps
- 89Wh Capacity
- USB-C Charging Port

SOR JNC345

Was ~~\$334.99~~
Now **\$249**

Was ~~\$209.99~~
Now **\$189**

Milwaukee® 29 PC. SHOCKWAVE IMPACT DUTY™ 1/2" DRIVE SAE & METRIC DEEP 6-POINT SOCKET SET
MIL 49667016



Was ~~\$419.99~~
Now **\$349**

Milwaukee® M18 FUEL™ 2-Tool Hammer Drill & Impact Driver Combo Kit
MIL 369722



Was ~~\$409~~
Now **\$379**

Milwaukee® M18 FUEL™ 1/2" High Torque Impact Wrench w/ Friction Ring Kit
MIL 296721B⁹⁹



\$353.99

Milwaukee® M18 FUEL™ Blower Kit
MIL 272421HD



\$199.99

Milwaukee® M12™ Underhood Light (Tool Only)
MIL 212520



\$282.99

Milwaukee® M18™ REDLITHIUM™ HIGH OUTPUT™ XC6.0 Battery - 2PK
MIL 48111862



Was ~~\$179~~
Now **\$149**

Milwaukee® M18™ Bluetooth® Jobsite Radio
MIL 295220⁹⁹



\$330.99

Milwaukee® M18 FUEL™ 16" Chainsaw (Tool Only)
MIL 272720



Was ~~\$254~~
Now **\$249**

MILWAUKEE® M18™ BRUSHLESS 18" FAN
MIL 082120⁹⁹



Have Tools & Equipment Product Questions? Scan Here



NTE COMM1000^{DS}
\$102 for 60 mos.



NTE COMM2000
\$135 for 60 mos.



NTE COMM3000
\$123 for 60 mos.



NTE COMM4000
\$180 for 60 mos.

NTE COMM1000^{DS} 134A SAE 2788 Certified Semi-automatic Was \$3897 Now \$3720
NTE COMM2000 134A SAE 2788 Certified Fully automatic Was \$5100 Now \$4905
NTE COMM3000 A/C Recovery Machine Portable R134A & Hybrid Mastercool Was \$5280 Now \$5079
NTE COMM4000 A/C Recovery Machine Portable R1234YF Mastercool Was \$7410 Now \$7430



A/C Recover, Recycle, and Recharge Machines Advanced Connected A/C Recovery and Recycling

Call for Special Pricing



Economy R134a
ROB 34288NI



Premier R134a
ROB 34788NI



Premier R134a
ROB 34788NIH



Premier R1234yf
ROB AC12344

Fully-automatic functions
Full wireless capabilities for Wi-Fi or Bluetooth® communication
Large 10.5" capacitive touch LCD display

Call for pricing

R-1234yf Connected
ROB AC12349
R-134a Connected
ROB 34998

For Hybrid & Non Hybrid



RTI 4608044600^{DS}
\$145 for 60 mos.

RTI 4608044900^{DS}
\$170 for 60 mos.

R1234yf Air Conditioning Service System

RTI 4608044600^{DS} ACX2250 Mid-Range \$6000
RTI 4608044900^{DS} ACX2280 High Performance \$7000



RTI 4608044500^{DS}
\$115 for 60 mos.

RTI 4608044700^{DS}
\$133 for 60 mos.

RTI 4608044800^{DS}
\$133 for 60 mos.

R134a Air Conditioning Service System

RTI 4608044500^{DS} ACX2150 Mid-Range \$4200
RTI 4608044700^{DS} ACX2180 High Performance \$4850
RTI 4608044800^{DS} ACX2180H High Performance Hybrid Certified \$4850

GET READY FOR SUMMER!

ROTARY A/C CARTS

R3AC50A / R134a GAS
RTY R3AC50A^{DS} Was \$5887 Now \$5879

R3AC60YF / R1234yf GAS
RTY R3AC60YF^{DS} Was \$8780 Now \$8639

R3AC80AYF / DUAL GAS
RTY R3AC80AYF^{DS} Was \$13950 Now \$13089



R3AC50A



R3AC60YF



R3AC80AYF

A/C Accessory Specials



Premium Leak Detector
For R-134a & R-1234yf
Was \$549.99
Now \$399.99
ROB LD7^{DS}



Add-On Printer
Was \$202.99
Now \$139.99
ROB 30038^{DS}

Syringe-Type Oil Injectors

For R-134a Service
PAG Labeled – ROB 18480^{DS} Was \$139.99 Now \$99.99
POE Labeled – ROB 18490^{DS} Was \$139.99 Now \$99.99
For R1234yf Service
PAG Labeled – ROB 18465^{DS} Was \$187.99 Now \$139.99
POE Labeled – ROB 18470^{DS} Was \$189.99 Now \$139.99



\$84.99

NTE EW40395^{DS}
Phazer Black Leak Detection Rechargeable UV Light w/Safety Glasses



NTE EW42085^{DS}
Pico UV Leak Detection Light w/Metal Clip



\$39.99



390100^{DS}
Spotgun Jr Universal Oil/Dye Starter Kit
\$209



390200^{DS}
Spotgun Jr Universal Oil/Dye Master Kit
\$264



490100^{DS}
Spotgun Universal Oil/Dye Starter Kit
\$179



490200^{DS}
Spotgun Universal Oil/Dye Master Kit
\$229



HEAVY-DUTY RECOVER, RECYCLE AND RECHARGE

FULLY AUTOMATIC FOR R134A REFRIGERANT SYSTEMS

NTE MXHD^{DS}

R-134a Single Gas RRR

- Designed for Large Capacity transit and Off-Road Systems
- Fully Automatic or user selectable manual functions
- Large, 8 CFM Vacuum Pump
- High-Capacity Compressor
- 18' Hose length
- 50lb tank (upgradeable to 90lb tank)
- 7" Color Touch Screen
- Wireless network printing

\$8509

\$206 for 60 mos.



MXHD (R-134A)

NEXT GENERATION RRR MANAGEMENT CENTERS ... ALL NEW MAXXAIR™ S-SERIES

HIGH-CAPACITY OILLESS COMPRESSOR REDUCES RECOVERY TIME UP TO 30% FASTER THAN THE COMPETITION

NTE MSX134^{DS}

R-134a Single Gas RRR

- Fully Automatic or user selected manual processes
- 7" Color Touch-Screen display featuring a graphic user interface that is fast and easy to navigate
- Wireless network printing
- On Board oil injection
- High Capacity oilless compressor significantly reduces recovery times

\$4899

\$135 for 60 mos.

NTE MSX3030^{DS}

R-134a/R-1234yf Dual Gas RRR

- Fully Automatic or user selected manual processes
- 7" Color Touch-Screen display featuring a graphic user interface that is fast and easy to navigate
- Wireless network printing
- Hybrid Ready
- High-Capacity oilless compressor significantly reduces recovery times
- Includes two 30lb tanks and hose sets

\$8790 \$213 for 60 mos.

NTE MSX1234^{DS}

R-1234yf Single Gas RRR

- Fully Automatic or user selected manual processes
- 7" Color Touch-Screen display featuring a graphic user interface that is fast and easy to navigate
- Wireless network printing
- Hybrid Ready
- High Capacity oilless compressor significantly reduces recovery times

\$6350

\$154 for 60 mos.

*DS = Special Order Item. Contact NAPA representative for lead time





Models Shown From Left to Right: POR PACA65001A1, POR PACA40001A1, POR PACA20001A1, POR PACA12001A1, POR PACA07001A1, POR PACA05001A1

PORTACOOOL®

PEAK COOLING, INTELLIGENT CONTROL

Spot Cooling (Apex 500, and 700)
Additional Benefits

- **Space Optimization** – Achieve maximum cooling without sacrificing space. Our slimmer profile and new front Intake allow you to place your Portacool cooler against any wall.
- **Digital louver control** – The fan outlet directs the airflow with digital motors, enabling customized cooling zones at the touch of a button.

Large Area Cooling (Apex 1200, 2000, 4000, and 6500)

- **Extended Cooling Reach** – Apex series of coolers delivers a refreshing breeze up to 60 feet away.
- **Whisper-Quiet Performance** – Redesigned motor reduces noise.
- **Simplify Your Space** – Our new housing design keeps cords and connections neatly tucked away.
- **Efficient Media Absorbance** – Portacool's proprietary advanced media technology helps achieve superior cooling efficiency while saving water and reducing costs with our eco-friendly solution.

APEX SERIES

Product SKU	Cooling Velocity (Sq. Ft.)	Air Flow (Mph)	Air Flow Reach (Ft.)	Water (G)	Dimensions (HxWxD)	Was Price	As Low As
POR PACA05001A1 ^{DS}	500	40	55	13	46x22x19.5	\$1299	\$1099
POR PACA07001A1 ^{DS}	700	37	60	22	52x27x24	\$1899	\$1599
POR PACA12001A1 ^{DS}	1200	25	40	40	58x42x26	\$2849	\$2399
POR PACA20001A1 ^{DS}	2000	28	60	45	68x54x30	\$3999	\$3199
POR PACA40001A1 ^{DS}	4000	25	50	55	77x63x33	\$4599	\$3799
POR PACA65001A1 ^{DS}	6500	24	45	66	90x78x39	\$6109	\$5000

\$110 for 12 mos.
\$161 for 12 mos.
\$131 for 24 mos.
\$102 for 48 mos.
\$104 for 60 mos.
\$138 for 60 mos.

MASTER

THE PROFESSIONAL'S CHOICE SINCE 1953

Cooling

MHR MAC18WB ^{DS}	18 in. High Velocity Wall Fan Black	Was \$249.99	Now \$129.99
MHR MAC20F ^{DS}	20" High Velocity Floor Fan	Was \$206.99	Now \$99.99
MHR MAC24DCT	24" Direct Drive Cradle Drum Fan Tilttable	Was \$278.99	Now \$159.99
MHR MAC24WOSC ^{DS}	24" H Velocity Oscillating Wall Mount Fan	Was \$268.99	Now \$179.99
MHR MAC30P	30" Pedestal Fan	Was \$316.99	Now \$219.99
MHR 36MACAPBDF ^{DS}	36" Belt Drive Barrel Fan	Was \$639.99	Now \$449.99
MHR MAC36BDF	36" Belt Drive Barrel Fan	Was \$487.99	Now \$399.99
MHR MAC42BDF	42" Belt Drive Barrel Fan	Was \$574.99	Now \$479.99
MHR 42MACAPBDF ^{DS}	42" Belt Drive Barrel Fan	Was \$708.99	Now \$529.99
MHR MAC48BDF	48" Belt Drive Barrel Fan	Was \$674.99	Now \$549.99
MHR 48MACAPBDF ^{DS}	48" Belt Drive Barrel Fan	Was \$769.99	Now \$599.99



MHR MAC18WW ^{DS}	Fan Circulation 18" 3 Speed UL507 White w/Wall Mount	Was \$219.99	Now \$129.99
MHR MAC30BCT	Fan Exhaust 24" Poly Flushmount w/ Alum-Shutter Poly-Blade	Was \$341.99	Now \$219.99
MHR MAC24W ^{DS}	Industrial 24" High Velocity Wall Mount Fan	Was \$329.99	Now \$169.99

BIG ASS FANS

COOL-SPACE®

EVAPORATIVE COOLERS \$179 for 12 mos.

BAF FEV11801 ^{DS}	300 18"	Was \$1899	Now \$1779
BAF F3502001 ^{DS}	350 24"	\$113 for 36 mos.	\$2899
BAF E4003601 ^{DS}	400 36"	\$112 for 48 mos.	\$3499
BAF E5005001 ^{DS}	500 50"	\$124 for 60 mos.	\$4499



BLACK JACK®

BAF 858435004373^{DS}

6' \$7499
\$182 for 60 mos.



SIDEKICK®

BAF FSK14801^{DS}

4' \$2599
\$101 for 36 mos.



BASIC 6®

\$124 for 60 mos.

BAF 840325212104 ^{DS}	14'	\$4499
		Was \$5760
BAF 840325212128 ^{DS}	18'	\$5730
		\$139 for 60 mos.
BAF 840325212111 ^{DS}	20'	\$5830
		\$141 for 60 mos.

E SERIES

BAF 858435004281 ^{DS}	7'	\$3799
		\$104 for 60 mos.
BAF 858435004403 ^{DS}	10'	\$4000
		\$110 for 60 mos.
BAF 858435004397 ^{DS}	12'	\$4199
		\$115 for 60 mos.

AIREYE®

BAF 810013332285 ^{DS}	24" Wall Mount	\$899
BAF 840325209487 ^{DS}	24" Pedestal	\$121 for 12 mos.
BAF 810013332339 ^{DS}	30" Wall Mount	\$949
BAF 840325209654 ^{DS}	30" Pedestal	Was \$4249 Now \$1199

\$121 for 12 mos.

Have Tools & Equipment Product Questions? Scan Here





Was ~~\$141.99~~
Now **\$99.49**

3 PC. WIRE STRIPPER SET CHT PSW3

HARDENED CUTTING EDGES
Provides superior strength and durability.

EXTREME VERSATILITY
Long nose and pistol grip perfect for tight spots.

STRIPS, CRIMPS AND CUTS
For insulated and non insulated wire from 10-22 AWG. and pistol grip perfect for tight spots.

ERGONOMIC HANDLE
Designed to reduce hand stress.



Was ~~\$53.99~~
Now **\$37.99**

11 PC. IMPACT INSERT BIT SET CHT IBS11
CHT IBS35 35 Pc. Impact Insert Bit Set Was ~~\$185.99~~ Now **\$109.00**
CHT IBS42 42 Pc. Impact Insert Bit Set Was ~~\$187.99~~ Now **\$119.00**



Was ~~\$42.99~~
Now **\$38.49**

SOFT FACE HAMMER CHT HSF2
CHT HFBP8 8 oz. Ball-Peen Hammer Was ~~\$39.99~~ Now **\$26.99**
CHT HFBP16 16 oz. Ball-Peen Hammer Was ~~\$37.99~~ Now **\$33.99**
CHT HFBP24 24 oz. Ball-Peen Hammer Was ~~\$42.99~~ Now **\$34.49**
CHT HFBP32 32 oz. Ball-Peen Hammer Was ~~\$48.99~~ Now **\$38.99**
CHT HFD25 40 oz. Fiberglass Drilling Hammer Was ~~\$39.99~~ Now **\$30.49**



Was ~~\$164.99~~
Now **\$149**

**2PC. PRYBAR SET
CHT PBF02**



CHT PBF10 10" Indexing Pry Bar Was ~~\$79.99~~ Now **\$63.99**
CHT PBF16 16" Indexing Pry Bar Was ~~\$107.99~~ Now **\$86.49**
CHT PBF24 24" Indexing Pry Bar Was ~~\$128.99~~ Now **\$125.00**

PLIER SETS & INDIVIDUALS



CHT PSLNPG3 3 Pc. Long Nose Pistol Grip Plier Set Was ~~\$146.99~~ Now **\$105.00**
CHT PSA3 3 Pc. Plier Set Was ~~\$103.99~~ Now **\$93.49**
CHT PSA4 4 Pc. Plier Set Was ~~\$149.99~~ Now **\$130.00**
CHT PSAJ3 3 Pc. Adjustable Jaw Plier Set Was ~~\$129.99~~ Now **\$97.49**
CHT LPCJEZ5 5" Curved Locking Plier Was ~~\$19.49~~ Now **\$17.49**
CHT LPCJEZ7 7" Curved Locking Plier Was ~~\$29.99~~ Now **\$26.99**
CHT LPCJEZ10 10" Curved Locking Plier Was ~~\$29.99~~ Now **\$26.99**
CHT LPLNEZ6 6" Long Nose Locking Plier Was ~~\$28.99~~ Now **\$25.99**
CHT LPCCEZ11 11" C-Clamp Plier Was ~~\$39.99~~ Now **\$35.99**
CHT WSCCPSA 10" Self-Adjusting Wire Stripper Was ~~\$50.99~~ Now **\$45.99**
CHT WSCCP Wire Stripper Plier Was ~~\$35.99~~ Now **\$33.49**

**CHT MBC8
8" MINI
BOLT CUTTER**
Was ~~\$81.99~~ Now **\$57.49**



EXTENSION & HEX KEYS

Was ~~\$9.99~~
Now **\$8.99**

3/8" DR. 6" EXTENSION CHT EXT3806

CHT EXT3802 3/8" Dr. 1-1/2" Extension Was ~~\$7.99~~ Now **\$7.19**
CHT EXT3820 3/8" Dr. 20" Extension Was ~~\$29.99~~ Now **\$26.99**
CHT EXT1202 1/2" Dr. 2" Extension Was ~~\$12.49~~ Now **\$10.99**
CHT EXT1206 1/2" Dr. 6" Extension Was ~~\$12.99~~ Now **\$12.49**
CHT EXT1210 1/2" Dr. 10" Extension Was ~~\$20.99~~ Now **\$18.99**
CHT EXT3405 3/4" Dr. 5" Extension Was ~~\$44.99~~ Now **\$40.49**
CHT EXT3408 3/4" Dr. 8" Extension Was ~~\$52.99~~ Now **\$48.49**
CHT EXT3416 3/4" Dr. 16" Extension Was ~~\$64.99~~ Now **\$55.99**
CHT SDSH2 2 Pc. Spinning T-Handle Set Was ~~\$97.99~~ Now **\$68.49**

Was ~~\$14.99~~
Now **\$13.49**

9 PC. SHORT HEX SET, SAE CHT HKFS9

CHT HKLS22 22 Pc. Long Hex Ball Key Set, Metric & SAE Was ~~\$52.99~~ Now **\$47.49**
CHT HKLMS9 9 Pc. Long Hex Ball Key Set, Metric Was ~~\$29.99~~ Now **\$25.99**
CHT HKLS13 13 Pc. Long Hex Ball Key Set, SAE Was ~~\$28.99~~ Now **\$25.99**



WRENCH SETS AND INDIVIDUALS

CHT AW6
CHT AW6 6" Adjustable Wrench Was ~~\$28.99~~ Now **\$25.99**
CHT AW10 10" Adjustable Wrench Was ~~\$45.99~~ Now **\$41.49**
CHT AW12 12" Adjustable Wrench Was ~~\$52.99~~ Now **\$48.49**
CHT AW15 15" Adjustable Wrench Was ~~\$66.99~~ Now **\$60.49**



COMBINATION LONG PATTERN WRENCH SETS
CHT CWL1211M 11 Pc. 12 Pt. Metric Was ~~\$175.99~~ Now **\$125.00**
CHT CWL1219M 19 Pc. 12 Pt. Metric Was ~~\$264.99~~ Now **\$315.00**

COMBINATION WRENCH SETS
CHT CW1219M 19 Pc. Metric Was ~~\$274.99~~ Now **\$245.00**
CHT CW1218 18 Pc. SAE Was ~~\$328.99~~ Now **\$305.00**
CHT CW1211 11 Pc. SAE Was ~~\$163.99~~ Now **\$149.00**

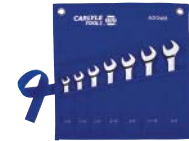

Was ~~\$147.99~~
Now **\$105**

7 PC. ANGLE WRENCH SET, SAE CHT ADOW8

CHT FNW5M 5 Pc. Metric Was ~~\$132.99~~ Now **\$120.00**
CHT FNW5 5 Pc. SAE Was ~~\$132.99~~ Now **\$120.00**

RATCHETING WRENCH SET
CHT RW1208 8 Pc. SAE Was ~~\$227.99~~ Now **\$165.00**
CHT RW1212M 12 Pc. Metric Was ~~\$324.99~~ Now **\$235.00**
CHT RW612M 12 Pc. Metric Was ~~\$202.99~~ Now **\$239.00**

CROWSFOOT WRENCH SET
CHT CF10 10 Pc. 3/8" Dr., SAE Was ~~\$174.99~~ Now **\$159.00**



Was ~~\$232.99~~
Now **\$165**

9 PC. SLIMLINE DOUBLE OPEN ENDED WRENCH SET CHT LTSW9M

SCREWDRIVER & NUTDRIVER



Was ~~\$85.99~~
Now **\$77.49**

**8 PC. COMBINATION SCREWDRIVER SET
CHT SDS8**

CHT SDS8GR 8 Pc. Screwdriver Set, Green Was ~~\$92.99~~ Now **\$84.49**
CHT SDSLP5 5 Pc. Low-Profile Screwdriver Set Was ~~\$37.99~~ Now **\$26.49**
CHT SDSLP5 5 Pc. Low-Profile Sar Was ~~\$37.99~~ Now **\$26.49**
CHT SDSP3XL 3 Pc. Extra-Long, Phillips Was ~~\$82.99~~ Now **\$58.99**
CHT SDSS3XL 3 Pc. Extra-Long, Slotted Was ~~\$82.99~~ Now **\$58.99**
CHT ND57 7 Pc. Nutdriver Set, SAE Was ~~\$75.99~~ Now **\$68.49**

Was ~~\$46.99~~
Now **\$32.99**

**19-IN-1 RATCHETING DRIVER BIT SET
CHT RDBS19**



SOCKET SETS & DRIVE ADAPTERS



Was ~~\$262.99~~
Now **\$185**

**3/8" DR. 49 PC. MASTER STAR, BIT SOCKET SET
CHT MSS3849**



Was ~~\$49.99~~
Now **\$34.99**

**1/4" & 3/8" DR. 10 PC. 10MM MASTER SOCKET SET
CHT SS1438010M**



Was ~~\$84.99~~
Now **\$59.49**

**3/8" DR. 12 PC. SOCKET SET, METRIC
CHT SSNS38012M**
CHT SSNS38011 3/8" Dr. 11 Pc. Socket Set, SAE Was ~~\$79.99~~ Now **\$55.99**



CHT SS14012 1/4" Dr. 12 Pc. 6 PT. Socket Set, Metric Was ~~\$48.99~~ Now **\$43.99**
CHT SS38017M 3/8" Dr. 17 Pc. 6 PT. Socket Set, SAE Was ~~\$147.99~~ Now **\$105.00**
CHT SS38014 3/8" Dr. 14 Pc. 6 PT. Socket Set, SAE Was ~~\$134.99~~ Now **\$92.49**
CHT SS38114 3/8" Dr. 14 Pc. 12 PT. Socket Set, SAE Was ~~\$126.99~~ Now **\$88.99**
CHT SS38015 3/8" Dr. 15 Pc. 6 PT. Socket Set, SAE Was ~~\$81.99~~ Now **\$73.99**
CHT SS12015M 1/2" Dr. 15 Pc. 6 PT. Socket Set, Metric Was ~~\$110.99~~ Now **\$99.99**
CHT SS12013 1/2" Dr. 13 Pc. 6 PT. Socket Set, SAE Was ~~\$94.99~~ Now **\$85.49**
CHT SS12008M 1/2" Dr. 8 Pc. 6 PT. Socket Set, Metric Was ~~\$87.99~~ Now **\$70.49**
CHT SS3413 3/4" Dr. 13 Pc. 12 PT. Socket Set, SAE Was ~~\$649.99~~ Now **\$455.00**



CHT SSD14014M 1/4" Dr. 14 Pc. 6 PT. Deep Socket Set, Metric Was ~~\$75.99~~ Now **\$68.49**
CHT SSD14009 1/4" Dr. 9 Pc. 6 PT. Deep Socket Set, SAE Was ~~\$48.99~~ Now **\$43.99**
CHT SSD14012 1/4" Dr. 12 Pc. 6 PT. Deep Socket Set, SAE Was ~~\$64.99~~ Now **\$58.49**
CHT SSD38019M 3/8" Dr. 19 Pc. 6 PT. Deep Socket Set, Metric Was ~~\$140.99~~ Now **\$125.00**
CHT SSD38014 3/8" Dr. 14 Pc. 3/8" Dr. 6 Pt. Deep Socket Set, SAE Was ~~\$104.99~~ Now **\$91.99**
CHT SSD12013 1/2" Dr. 13 Pc. 1/2" Dr. 6 Pt. Deep Socket Set, SAE Was ~~\$168.99~~ Now **\$150.00**

Was ~~\$268.99~~
Now **\$240**

**1/4" & 3/8" DR. 42 PC. MASTER HEX BIT SOCKET SET
CHT BSH42**



Was ~~\$348.99~~
Now **\$315**

**1/4", 3/8" & 1/2" DR. 41 PC. MASTER STAR & HEX SET
CHT BSTH41**



Was ~~\$142.99~~
Now **\$129**

**14 PC. 3/8" DR. OIL DRAIN PLUG SOCKET SET
CHT BSODP14**



Was ~~\$78.99~~
Now **\$70.99**

**12 PC. LONG STAR BIT SOCKET SET
CHT BSLT12**



Was ~~\$94.99~~
Now **\$85.49**

**12 PC. STAR PLUS BIT SOCKET SET
CHT BSTP12**



CHT BSET11 1/4", 3/8" & 1/2" Dr. 11 Pc. External Star Bit Socket Set Was ~~\$94.99~~ Now **\$85.49**
CHT BST13 1/4", 3/8" & 1/2" Dr. 13 Pc. Star Bit Socket Set Was ~~\$104.99~~ Now **\$94.49**
CHT BSTS3808 3/8" Dr. Triple Square Bit Socket Set Was ~~\$74.99~~ Now **\$67.49**
CHT BSH1207 1/2" Dr. 7 Pc. Hex Bit Sockets & Sets Was ~~\$96.99~~ Now **\$87.49**
CHT BSTH13 1/4", 3/8" & 1/2" Dr. 13 Pc. Tamper-Proof Star Bit Socket Set Was ~~\$128.99~~ Now **\$115.00**
CHT BSLTS8 3/8" & 1/2" Dr. 8 Pc. Long Triple Square Bit Socket Set Was ~~\$96.99~~ Now **\$86.49**
CHT BSH3812M 3/8" Dr. 12 Pc. Hex Bit Socket Set, Metric Was ~~\$76.99~~ Now **\$69.49**
CHT BSH3812 3/8" Dr. 12 Pc. Hex Bit Socket Set, SAE Was ~~\$84.99~~ Now **\$76.49**
CHT BSTTP11 1/4" & 3/8" Dr. 11 Pc. Tamper-Proof 5 Star Plus Bit Socket Set Was ~~\$76.99~~ Now **\$68.49**

CHT SR12B 1/4" Dr. Socket Holder Rail, Blue Was ~~\$4.99~~ Now **\$3.29**
CHT SR15R 1/4" Dr. Socket Holder Rail, Red Was ~~\$5.99~~ Now **\$4.79**

Was ~~\$273.99~~
Now **\$219**

**3/8" CLICK STYLE RANGE 10-100FT/LBS
CHT TW38TD1**



Was ~~\$273.99~~
Now **\$190**

**1/4" DR. CLICK STYLE RANGE 5-50IN/LBS
CHT TW14RH1**



Was ~~\$869.99~~
Now **\$785**

**3/4" DR. 38" LONG, 72 TEETH, 100-600FT/LBS
CHT TW34**



Was ~~\$348.99~~
Now **\$315**

**1/2" DR. 24" LONG, 25-250FT/LBS
CHT TW12RH1**



GEARWRENCH

Mechanics Tool Sets



115 Pc. 1/4" & 3/8" Drive 6 Point Standard & Deep SAE/Metric Mechanics Tool Set
\$96⁸⁹
 Item No. APX 88001

179 Pc. 1/4", 3/8" & 1/2" Drive SAE/Metric Mechanics Mechanics Tool Set
\$146
 Item No. APX 88002

42" Mobile Work Station & 613 Pc. Master Set with 11 EVA Foam Trays

42" 11-Drawer Black & Orange Mobile Work Station
 Item No. APX 83169 ⁰⁵

613 Pc. Master Mechanics Tool Set
 Item No. APX 89060 ⁰⁵

11 EVA Foam Trays
 Item No. APX 89060EVA ⁰⁵

CALL FOR PRICING



Shop Equipment

Adjustable Height Mobile Work Table
\$143
 Item No. APX 83166 ⁰⁵

Adjustable Height Swivel Mechanics Seat
\$123
 Item No. APX 86994 ⁰⁵



Screwdriver & Plier Sets



20 Pc. Phillips®/Slotted/Torx® Dual Material Screwdriver Set
\$83⁰⁹
 Item No. APX 80066H

6 Pc. Pitbull Dual Material Mixed Plier Set
\$110
 Item No. APX 82204C06 ⁰⁵

Tap & Die Sets

77 Pc. SAE/Metric Ratcheting Tap & Die Set
\$153
 Item No. APX 3887

114 Pc. SAE/Metric Ratcheting Tap & Die Set
\$256⁰⁶
 Item No. APX 82812



Pry Bars

48" Extendable Indexing Pry Bar
\$111
 Item No. APX 82248



Bolt Biter™ Extraction Tools and Impact Sets

28 Pc. Bolt Biter™ Impact Extraction Socket Set
\$153
 Item No. APX 84784



15 Pc. 1/4" & 3/8" Drive Bolt Biter™ Impact Extraction Socket Set
\$119
 Item No. APX 84783 ⁰⁵



30 Pc. Bolt Biter™ SAE/Metric Insert Wrench Set
\$130
 Item No. APX 86193 ⁰⁵



Wrench Sets

16 Pc. 72-Tooth 12 Pt. Ratcheting Combination Metric Wrench Set
\$137
 Item No. APX 9416



14 Pc. 72-Tooth 12 Point Reversible Ratcheting Combination SAE/Metric Wrench Set
\$89⁹⁹
 Item No. APX 85142



13 Pc. 72-Tooth 12 Pt. Ratcheting Combination SAE Wrench Set
\$130
 Item No. APX 9312



14 Pc. 72-Tooth 12 Point Flex Head Ratcheting Combination SAE/Metric Wrench Set
\$89⁹⁹
 Item No. APX 85141



32 Pc. 72-Tooth 12 Point SAE/Metric Standard/Stubby Combination Ratcheting Wrench Set
\$119
 Item No. APX 39327

Socket Sets

20 Pc. 3/8" Drive 12 Pt. SAE/Metric Mechanics Tool Set
\$29⁴⁹
 Item No. APX 8801A



23 Pc. 3/8" Drive Pass-Thru™ 6 Pt. SAE/Metric Mechanics Tool Set
\$80¹⁹
 Item No. APX 893823



22 Pc. 1/4" Drive 6 Pt. SAE/Metric Mechanics Tool Set
\$23⁴⁹
 Item No. APX 8800A



46 Pc. 1/4" & 3/8" Drive Pass-Thru™ 6 Pt. SAE/Metric Tool Set
\$88⁰⁹
 Item No. APX 8946



243 Pc. 12 Point Mechanics Tool Set in 3 Drawer Storage Box
\$319
 Item No. APX 80972 ⁰⁵



56 Pc. 3/8" Drive 6 Point 120XP™ Standard & Deep SAE/Metric Mechanics Tool Set
\$121
 Item No. APX 80550P



84 Pc. 1/4", 3/8" & 1/2" Drive Hex/Ball End Hex/Tamper Proof Torx®/External Torx®/Torx® SAE/Metric Bit Set
\$99⁹⁹
 Item No. APX 80742



Torque Wrench & Ratchets

1/2" Drive Tire Shop Micrometer Torque Wrench
\$180
 Item No. APX 85088M



2 Pc. 1/4" & 3/8" Drive 90 Tooth Long Handle Teardrop Ratchet Set
\$62²⁹
 Item No. APX 81268T



3 Pc. 1/4" & 3/8" Drive 90-Tooth Dual Material Teardrop Ratchet Set
\$130
 Item No. APX 81203T ⁰⁵



2 Pc. 3/8" Drive 120-Tooth Extra Long Handle Ratchet Set
\$76¹⁹
 Item No. APX 81271



2 Pc. 1/4" & 3/8" Drive 120XP™ Dual Material Handle Locking Flex Head Ratchet Set
\$118
 Item No. APX 81381 ⁰⁵



Apex Tool Group, LLC
 1000 Lufkin Road
 Apex, NC 27539
 www.apextoolgroup.com
 ©2023 Apex Tool Group, LLC



GEARWRENCH and the GEARWRENCH logo are registered trademarks of Apex Brands, Inc.
 Specifications subject to change without notice.
 ATG-46538

FORGE AHEAD

Have Tools & Equipment Product Questions? Scan Here



REAL DEALS — 07



Was ~~\$124~~
Now **\$110**
Carlyle® Automatic Transmission Refill Adaptors
SER 71201™



Was ~~\$400.99~~
Now **\$360**
Carlyle® Pressure Brake Bleeder Kit 6 Adapters
SER 9000



Was ~~\$310.99~~
Now **\$219**
Carlyle® QuickFlow Brake Bleeder
SER 71800



Was ~~\$70.99~~
Now **\$63.99**
Carlyle® TestVac Brake Bleeding Kit Vacuum Pump
SER 80031

Power Team®

UNMATCHED SAFETY & CONTROL WITH POSI LOCK® PULLERS



Machine jaws specially designed for snap-ring grooves.

T-Handle and safety cage provide the technician safe and easy operation

- T-Handle locks jaws precisely where you set them
- Safety cage guides jaws for a fast set-up and solid contact
- Slim, tapered jaws allow better gripping and access to tight spots
- Assembled in the USA

SPXFLOW®
spxflow.com/power-team

Model	Price	Jaws	Reach	Spread Range	Weight	Center Bolt Dia.	Jaw Width	Hex Socket Size
			in	in				
POL PT106	\$246.99	3	6.00	0.5 to 7.0	8.00	0.62	0.75	0.75
POL PT108	\$328.99	3	8.00	0.75 to 12.0	14.00	0.75	0.88	1.00
POL PT110	\$354.99	3	9.67	1.0 to 15.0	16.00	0.75	1.00	1.00



Was ~~\$649~~
Now **\$584**
Mini-Ductor Venom HP
BK MDV787™



Was ~~\$119~~
Now **\$109**
Coil Kits

BK MD99660	Essential	Was \$149	Now \$139
BK MD99650	Standard	Was \$164	Now \$165
BK MD99675™	Long		

THE WORLD'S MOST DURABLE SLEDGE HAMMER



FREE
4 LB. 12" BASH HAMMER INCLUDED
\$48.99 VALUE



Was ~~\$239.99~~
Now **\$235.99**
Green Utility Vise, B.A.S.H.® Hammer Kit
• Includes Green 6-1/2" utility vise (JET 11128) and 4 lb. sledge hammer (JET 20412)
JET 11128BH

Sledge Hammers

JET 20212	2-1/2 lb. Head, 12" Handle	\$53.99
JET 20412	4 lb. Head, 12" Handle	\$61.99
JET 20416	4 lb. Head, 16" Handle	\$73.99
JET 20624	6 lb. Head, 24" Handle	\$94.99
JET 20824	8 lb. Head, 24" Handle	\$109.99
JET 21030	10 lb. Head, 30" Handle	\$136.99

Ball Pein Hammers

JET 32414	24 oz. Head, 14" Handle	\$49.99
JET 33214	32 oz. Head, 14" Handle	\$55.99

Dead Blow Hammers

JET 55214	2 lb. Head, 14" Handle	\$54.99
JET 55416	4 lb. Head, 16" Handle	\$85.99



*DS = Special Order Item. Contact NAPA representative for lead time



Was ~~\$74⁹⁹~~
Now **\$67⁴⁹**
Carlyle® Disc Brake Pad Spreaders
SER 279



Was ~~\$50⁹⁹~~
Now **\$45⁹⁹**
Carlyle® Radiator Funnel Kits
SER 24680

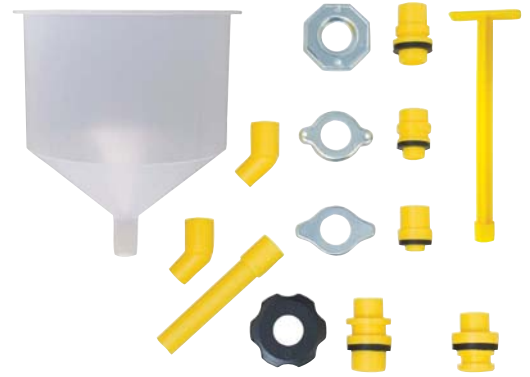

Was ~~\$17⁴⁹~~
Now **\$15⁴⁹**
Carlyle® Disc Brake Piston Tools
SER 3163



Was ~~\$35⁹⁹~~
Now **\$32⁴⁹**
Carlyle® Bearing Packer Tools
SER 774005



Was ~~\$28⁹⁹~~
Now **\$25⁹⁹**
Carlyle® A/C & Fuel Line Quick Disconnect Sets
SER 3530



Was ~~\$32⁹⁹~~
Now **\$29⁴⁹**
Carlyle® Disconnect Tool Set Angled
SER 39400



Was ~~\$28⁹⁹~~
Now **\$25⁹⁹**
Carlyle® Pliers Hose Pinch Off
SER 1470



Was ~~\$55⁹⁹~~
Now **\$50⁴⁹**
Carlyle® AXLe Spindle Nut Socket 3-1/4 in. SAE
SER 2449



Was ~~\$38⁹⁹~~
Now **\$34⁹⁹**
Carlyle® Wheel Stud Installer
SER 22800



Was ~~\$30⁹⁹~~
Now **\$27⁹⁹**
Snap Ring Pliers Combination Heavy Duty
SER 1715



Was ~~\$17⁹⁹~~
Now **\$15⁹⁹**
Tube & Tubing Cutters
SER 2107



Was ~~\$372⁹⁹~~
Now **\$335**
Mastercool 27 pc. Master Cooling System Pressure Test Kit
BK 7003701⁹⁹



Was ~~\$23⁹⁹~~
Now **\$21⁴⁹**
Carlyle® Seal Pullers
SER 3245



Was ~~\$51⁹⁹~~
Now **\$46⁹⁹**
Carlyle® Oxygen Sensor Sockets
SER 3259



Was ~~\$16⁴⁹~~
Now **\$14⁹⁹**
Carlyle® Oil Pressure Switch Sockets
SER 3458



Was ~~\$47⁹⁹~~
Now **\$42⁹⁹**
Carlyle® Fixed-Joint Oil Filter Wrench Pliers 2 15/16 in.-3 5/8 in.
SER 773368



Was ~~\$89⁹⁹~~
Now **\$80⁹⁹**
Carlyle® Step Drill Bit Set 3 pc.
SER M35SDBS3



Was ~~\$114⁹⁹~~
Now **\$105**
Carlyle® Infrared Thermometer with Laser
Temperature Range of -36.4° to 689° F
SER 783880



Was ~~\$2070~~
Now **\$1865**
R134a and R1234yf Dual Complete Air Conditioning Recovery Machine
NTE 69372



REAL TOOLS FOR REAL WORK.

Was ~~\$789⁹⁹~~
Now **\$599⁹⁹**
2145QIMAX 3/4" Drive Air Impact Wrench Quiet 1700 ft.-lbs. MAX Torque Maintenance Duty, Pistol Grip, Standard Anvil
IR 2145QIMAX



Was ~~\$197⁹⁹~~
Now **\$159⁹⁹**
231C 1/2" Drive Air Powered Impact Wrench 600 ft.-lbs. MAX. Reverse Torque Super Duty Pistol Grip, Standard Anvil
IR 231C



Was ~~\$494⁹⁹~~
Now **\$369⁹⁹**
W7152 20V High-Torque 1/2" Drive Cordless Impact Wrench 1500 ft.-lbs. MAX Torque Standard Anvil
IR W7152⁹⁹



Was ~~\$709⁹⁹~~
Now **\$499⁹⁹**
W7152-K12 20V High-Torque 1/2" Drive Cordless Impact Wrench Kit 1500 ft.-lbs. MAX Torque 1 Battery and Charger Standard Anvil
IR W7152K12⁹⁹



Was ~~\$874⁹⁹~~
Now **\$649⁹⁹**
285B-6 1" Drive Air Powered Impact Wrench 1475 ft.-lbs. MAX. Reverse Torque Heavy Duty D-handle, Inside Trigger, 6" Extended Anvil
IR 285B6



Was ~~\$97⁹⁹~~
Now **\$74⁹⁹**
301B Right Angle Air Die Grinder 0.25 Collet Burr 21000 RPM Front Exhaust, 0.25 HP
IR 301B



Was ~~\$849⁹⁹~~
Now **\$629⁹⁹**
W7152-K22 20V High-Torque 1/2" Drive Cordless Impact Wrench Kit 1500 ft.-lbs. MAX. Reverse Torque 2 Batteries and Charger Standard Anvil
IR W7152K22⁹⁹



Was ~~\$1600~~
Now **\$1130**
W9691 20V High-Torque 1" Drive Cordless Impact Wrench 3000 ft.-lbs. MAX Torque 6" Extended Anvil
IR W9691⁹⁹



Was ~~\$2230~~
Now **\$1600**
W9691-K4E 20V High-Torque 1" Drive Cordless Impact Wrench Kit 3000 ft.-lbs. MAX Torque 4 Batteries and Charger 6" Extended Anvil
IR W9691K4E⁹⁹



Have Tools & Equipment Product Questions? Scan Here

CARLYLE TOOLS by **NAPA**



Was ~~\$328⁹⁹~~
Now **\$289**

1/2" Drive High Performance Impact Wrench

- Precise variable speed trigger
- Hose end thread diameter: 1/4 in-18 NPT
- Easy directional change with rear forward/reverse push buttons
- 4 position regulator allows for controlled power output in forward direction

NPT 62610



Was ~~\$248⁹⁹~~
Now **\$225**

1/2" Dr. Super Duty Air Impact Wrench

- Powerful twin hammer mechanism design produces 1,100 ft. lbs. of breakaway torque

NPT 6767



Was ~~\$94⁹⁹~~
Now **\$66⁴⁹**

1/4" Drive Mini Metal Die Grinder BOGO Pack

- Metal housing creates a highly durable tool
- Lightweight feel and variable speed trigger
- Compact design allows for access in tight areas

NPT 62613



Was ~~\$834⁹⁹~~
Now **\$750**

3/4" Dr. Super Duty Air Impact Wrench w/ 6" Extended Anvil

NPT 61126^{DS}



Was ~~\$238⁹⁹~~
Now **\$209**

1/2" Dr. Heavy Duty Twin Hammer Impact Wrench with 2" Ext. Anvil

NPT 6232



Was ~~\$314⁹⁹~~
Now **\$220**

3/8" Dr. Super Duty Air Impact Wrench

NPT 61122



Was ~~\$328⁹⁹~~
Now **\$295**

1/2" Dr. Super Duty Air Impact Wrench

NPT 61123



Was ~~\$174⁹⁹~~
Now **\$159**

1/2" Dr. Heavy Duty Twin Hammer Impact Wrench

NPT 6231



Was ~~\$292⁹⁹~~
Now **\$235**

1/2" Dr. Snub Nose Air Impact Wrench

NPT 61083

3/8" Dr. Snub Nose Air Impact Wrench

NPT 61084^{DS} Was ~~\$296⁹⁹~~ Now **\$209**



Was ~~\$1320~~
Now **\$1189**

1" Dr. Super Duty Air Impact Wrench w/ 8" Extended Anvil

NPT 61138



Was ~~\$604⁹⁹~~
Now **\$545**

3/4" Dr. Super Duty Air Impact Wrench

- Powerful twin hammer mechanism design produces 1,600 ft. lbs. of breakaway torque

NPT 6768



Was ~~\$804⁹⁹~~
Now **\$725**

3/4" Drive Super Duty Air Impact Wrench

NPT 61125



Was ~~\$919⁹⁹~~
Now **\$829**

1" Dr. Heavy Duty Air Impact Wrench w/ 6" Extended Anvil

- Rear dial allows tech to adjust power setting as well as easily change tool direction
- Variable speed throttle gives the user precise control

NPT 6709^{DS}



Was ~~\$974⁹⁹~~
Now **\$879**

1" Dr. Heavy Duty Air Impact Wrench

- Rear dial allows tech to adjust power setting as well as easily change tool direction
- Variable speed throttle gives the user precise control

NPT 6710^{DS}



Was ~~\$809⁹⁹~~
Now **\$729**

1" Drive Heavy Duty Air Impact Wrench w/ 9" Extended Anvil

- Lightweight aluminum housing
- Rocking dog mechanism 1,600 ft. Lbs. of torque
- Six speeds: 3 forward / 3 reverse

NPT 61137



3/8" Drive Air Impact Ratchet

NPT 61132^{DS} Was ~~\$274⁹⁹~~ Now **\$249**

3/8" Drive Heavy Duty Air Ratchet

NPT 61127 Was ~~\$362⁹⁹~~ Now **\$255**



Was ~~\$195⁹⁹~~
Now **\$175**

Low Vibration Long Barrel Air Hammer

- Vibration reduction design

NPT 61080



Was ~~\$146⁹⁹~~
Now **\$130**

Air Hammer with Comfort Grip

- Quick change chisel retainer

NPT 61012



Was ~~\$97⁹⁹~~
Now **\$87⁹⁹**

Air Hammer Medium Duty

- Accepts .401 diameter taper
- Shank chisel

NPT 61020



Was ~~\$228⁹⁹~~
Now **\$205**

7" Needle Scaler

NPT 61050



Was ~~\$203⁹⁹~~
Now **\$185**

Straight 5" Needle Scaler

NPT 61061



1/4" Dr. Die Grinder

- Robust 1/2 HP for maximum performance
- Variable speed locking throttle

NPT 6754 Was ~~\$156⁹⁹~~ Now **\$140**

1/4" Dr. Right Angle Die Grinder

NPT 6755 Was ~~\$156⁹⁹~~ Now **\$140**



Was ~~\$152⁹⁹~~
Now **\$139**

Utility Cut-Off Tool

- Robust 1/2 HP @ 21,000 RPM
- Variable speed locking throttle
- Rotatable rear exhaust

NPT 63802



Was ~~\$266⁹⁹~~
Now **\$240**

Heavy Duty Metal Shear

- Shear Cuts 18 Gauge 1.2mm mild steel
- Variable speed locking throttle

NPT 6701



Was ~~\$137⁹⁹~~
Now **\$125**

High Speed Air Saw

- Adjustable guard for precise depth of cut control
- Cuts straight or curved patterns

NPT 61013



Was ~~\$215⁹⁹~~
Now **\$195**

Heavy Duty Air Nibbler

- Smoothly Cuts 18 Gauge
- 1.2mm mild steel
- Variable speed locking throttle

NPT 6711



3/16" 6" Random Orbital Sander

- Variable speed throttle
- Powerful 0.3 HP provides 12,000 RPM
- Low-noise technology

NPT 61151^{DS} Was ~~\$194~~ Now **\$155**

3/32" 6" Random Orbital Sander

NPT 61152^{DS} Was ~~\$194~~ Now **\$135**



Was ~~\$259~~
Now **\$180**

3/32" 3" Random Orbital Sander

- Variable speed throttle
- Powerful 0.3 HP provides 12,000 RPM
- Low-noise technology

NPT 61153^{DS}



Was ~~\$139~~
Now **\$125**

3/8" X 13" Belt Sander

- Variable speed throttle
- Easy tool-less belt changing
- 0.7 HP motor with quiet technology

NPT 61154^{DS}



Was ~~\$189~~
Now **\$170**

3" In-Line Cut Off Tool

- 0.9 HP variable speed motor
- 2.25 lbs to reduce fatigue
- Comfort grip protects from cold
- Works with 3" accessories

NPT 61156^{DS}



Was ~~\$184~~
Now **\$165**

1/2" X 18" Belt Sander

- Variable speed throttle
- Easy tool-less belt changing
- 0.7 HP motor with quiet technology

NPT 61155^{DS}

*DS = Special Order Item. Contact NAPA representative for lead time



DEWALT



Was ~~\$369~~
Now \$349 DEW DCK0222M1^{DS}
 20V MAX* XR® Cordless Folding String Trimmer and Handheld Blower Combo Kit

BUY



\$329 DEW DCST972X1^{DS}
 60V MAX* 17 in. Brushless Attachment Capable String Trimmer Kit

SELECT ONE ATTACHMENT FOR FREE



Brush Cutter Attachment
 RETAIL VALUE \$94
 DEW DWOAS5BC^{DS}



Articulating Hedge Trimmer Attachment
 RETAIL VALUE \$119
 DEW DWOAS8HT^{DS}



Blower Attachment
 RETAIL VALUE \$84.80
 DEW DWOAS7BL^{DS}



Edger Attachment
 RETAIL VALUE \$94
 DEW DWOAS4ED^{DS}



Pole Saw Attachment
 RETAIL VALUE \$119
 DEW DWOAS6PS^{DS}



\$369 DEW DCF961B^{DS}
 20V MAX* XR® Brushless Cordless 1/2 in. High Torque Impact Wrench with Hog Ring Anvil (Tool Only)



Was ~~\$249~~
Now \$229 DEW DCF510B^{DS}
 20V MAX* XR® Brushless 3/8 in. & 1/2 in. Sealed Head Ratchet (Tool Only)



Was ~~\$159~~
Now \$139 DEW DCD800B^{DS}
 20V MAX* XR® Brushless Cordless 1/2 in. Drill/Driver (Tool Only)



Was ~~\$149~~
Now \$129 DEW DCF845B^{DS}
 20V MAX* XR® 3-Speed Impact 1/4 in. Driver (Tool Only)

NEW PRODUCT



\$959 DEW DCF414GE2^{DS}
 20V MAX* XR® Brushless 1/4" Rivet Tool Kit with Battery and Charger

\$799 DEW DCF414B^{DS}
 20V MAX* XR® Brushless 1/4" Rivet Tool (Tool Only)

- DESIGNED FOR EASE OF USE with tool-free nose piece change and on-board nose piece storage
- COMPATIBLE WITH MULTIPLE RIVET SIZES including 3/16", 15/64", and 1/4" rivets

\$379 DEW DCF403D1^{DS}
 20V MAX* XR® Brushless Cordless 3/16" Rivet Tool Kit with Battery and Charger

\$299 DEW DCF403B^{DS}
 20V MAX* XR® Brushless Cordless 3/16" Rivet Tool Kit (Tool Only)

- Up to 2,100 LBF. of Pulling Force
- 0.98" Stroke Length

\$349 DEW DCF510GE1^{DS}
 20V MAX* XR® Brushless Cordless 3/8" & 1/2" Sealed Head Ratchet with POWERSTACK™ Battery and Charger

\$229 DEW DCF510B^{DS}
 20V MAX* XR® Brushless Cordless 3/8" & 1/2" Sealed Head Ratchet (Tool Only)

- BRUSHLESS MOTOR delivers 75 ft-lbs of max torque and a no-load speed of 0-300 RPM
- Interchangeable anvils

\$299 DEW DCF500GG1^{DS}
 XTREME™ 12V MAX* Brushless Cordless 3/8" & 1/4" Sealed Head Ratchet Kit

- BRUSHLESS MOTOR delivers 50 ft-lbs of max torque and a no-load speed of 0-450 RPM
- Interchangeable anvils

\$279 DEW DCBP520G^{DS}

\$144 DEW DCBP034G^{DS}

- POWERSTACK™ 20V Battery**
- Oil Resistant
 - Rubber Bumper Coated
 - Battery Fuel Gauge

\$389 DEW DCM200E1^{DS}

20V MAX* XR® 18" Bandfile with POWERSTACK™ Battery and Charger

\$289 DEW DCM200B^{DS}
 20V MAX* XR® 18" Bandfile (Tool Only)

- Belt Speed (No Load) 1,970 - 5,600 ft./min
- Changeable contact arm for multiple applications



\$529 DEW DCF961GP1^{DS}
 20V MAX* XR® Brushless Cordless 1/2" High Torque Impact Wrench with Hog Ring Anvil Kit with Battery and Charger

\$369 DEW DCF961B^{DS}
 20V MAX* XR® Brushless Cordless 1/2" High Torque Impact Wrench with Hog Ring Anvil (Tool Only)

- Max Fastening Torque 1,200 ft-lbs
- Max Breakaway Torque 1,750 ft-lbs
- Increase user control with PRECISION WRENCH™ control, variable speed trigger, and LED brightness adjustment
- After 4 seconds of impacting, the tool automatically provides an increase in power to aid in loosening stubborn fasteners

With respect to 20V MAX and 12V MAX*, maximum initial battery voltage (measured without a workload) is 20 Volts (Nominal is 18V) and 12 Volts (Nominal is 10.8V)

GUARANTEED TOUGH.™





TO CLAIM YOUR GIFT CARD(S) AND/OR FREE ITEM(S)

PLEASE GO TO WWW.MILWAUKEETOOL.COM/E-REBATES/NAPA OR **SCAN THE QR CODE** ON THIS PAGE.

Redemptions must be completed by July 15, 2024. For NAPA online orders, please enter NAPAWEB when prompted for a zip code.



SCAN TO REDEEM

PURCHASE A QUALIFYING **M12** BARE TOOL

GET THIS FREE

\$202⁹⁹

M12 FUEL™ HATCHET™ 6" Pruning Saw (Tool Only)
MIL 252720^{DS}



\$199⁹⁹

M12™ Underhood Light (Tool Only)
MIL 212520



\$200⁹⁹

M12 FUEL™ 1/4" High Speed Ratchet (Tool Only)
MIL 256620



\$200⁹⁹

M12 FUEL™ 3/8" High Speed Ratchet (Tool Only)
MIL 256720



\$249

M12 FUEL™ 3/8" Extended Reach High Speed Ratchet (Tool Only)
MIL 256920^{DS}



\$152⁹⁹

M12™ Radio + Charger
MIL 295120



\$249⁹⁹

M12 FUEL™ 1/2" x 18" Bandfile - Tool Only
MIL 248220^{DS}



\$201⁹⁹

M12 FUEL™ 3/8" Stubby Impact Wrench - Tool Only
MIL 255420



\$201⁹⁹

M12 FUEL™ 1/2" Stubby Impact Wrench - Tool Only
MIL 255520



\$150⁹⁹

M12 FUEL™ 3" Compact Cut-Off Tool (Tool Only)
MIL 252220



M12™ REDLITHIUM™ CP2.5 Battery
MIL 48112425

\$79 VALUE



PURCHASE A QUALIFYING **M12** FUEL KIT

GET THIS FREE

\$211⁹⁹

M12 FUEL™ 1/4" Hex 2-Speed Screwdriver Kit
MIL 240222^{DS}



\$179⁹⁹

M12 FUEL™ 1/2" Drill/Driver Kit
MIL 340322



M12™ REDLITHIUM™ CP2.5 Battery
MIL 48112425

\$79 VALUE



PURCHASE A QUALIFYING **M12** FUEL KIT

GET BOTH FREE

\$323⁹⁹

M12 FUEL™ 1/4" Right Angle Die Grinder 2-Battery Kit
MIL 248522



\$323⁹⁹

M12 FUEL™ 1/4" Straight Angle Die Grinder 2-Battery Kit
MIL 248622



2" Metal Cut-Off Wheel - 5PK
MIL 49942000

\$15 VALUE

M12™ REDLITHIUM™ XC5.0 Battery
MIL 48112450

\$119 VALUE



SPECIAL PRICING

Was ~~\$99⁹⁹~~
Now **\$69**

M12™ REDLITHIUM™ XC1.5 Battery - 2PK
MIL 48112411^{DS}



Was ~~\$130⁹⁹~~
Now **\$99**

M12™ REDLITHIUM™ XC3.0 Battery - 2PK
MIL 48112412^{DS}



Was ~~\$419⁹⁹~~
Now **\$349**

M18 FUEL™ 2-Tool Hammer Drill & Impact Driver Combo Kit
MIL 369722



Was ~~\$409~~
Now **\$379**

M18 FUEL™ 1/2" High Torque Impact Wrench w/ Friction Ring 1 Battery Kit
MIL 2967218^{DS}



PURCHASE THIS **M18** COMBO KIT

\$584⁹⁹

M18™ Cordless 4-Tool Combo Kit
MIL 269624^{DS}



YOUR CHOICE GET 2 FREE

M18™ Brushless 4-1/2" / 5" Cut-Off Grinder, Paddle Switch (Tool Only)
MIL 268620

\$149 VALUE



M18™ 1/2" Brushed High Torque Impact Wrench w/ Friction Ring (Tool Only)
MIL 266320

\$219 VALUE



M18™ Random Orbit Sander (Tool Only)
MIL 264820

\$129 VALUE



M18™ Cordless Multi-Tool (Tool Only)
MIL 262620

\$129 VALUE



M18™ 6-1/2" Circular Saw (Tool Only)
MIL 263020

\$130 VALUE



*DS = Special Order Item. Contact NAPA representative for lead time



COMMODORE FINANCING

SPECIAL PRICING



Was ~~\$719~~
Now **\$499**
M18 FUEL™ 1/2" High Torque Impact wrench w/ Friction Ring & Grease Gun Combo Kit
MIL 296722GG^{SS}



Was ~~\$231⁹⁹~~
Now **\$169**
M18™ & M12™ Rapid Charge Station
MIL 48591807



Was ~~\$249~~
Now **\$199**
M18™ Dual Bay Simultaneous Super Charger
MIL 48591815^{SS}



Was ~~\$120⁹⁹~~
Now **\$99**
M18™ ROVER™ Mounting Flood Light
MIL 236520



Was ~~\$179~~
Now **\$149**
M18™ Bluetooth® Jobsite Radio
MIL 295220^{SS}

PURCHASE A QUALIFYING M18 FUEL KIT



\$319⁹⁹
M18 FUEL™ 1/2" Drill/Driver Kit
MIL 290322



\$309⁹⁹
M18 FUEL™ 1/4" Hex Impact Driver Kit
MIL 295322

GET THIS FREE



M18™ REDLITHIUM™ XC5.0 Resistant Battery
MIL 48111850R
\$190 VALUE

PURCHASE THIS M18 FUEL BARE TOOL



\$909⁹⁹
M18 FUEL™ 1" D-Handle Ext. Anvil High Torque Impact Wrench w/ ONE-KEY™
MIL 286920

GET THIS FREE



M18™ REDLITHIUM™ HIGH OUTPUT™ HD12.0 Battery
MIL 48111812
\$250 VALUE

PURCHASE A QUALIFYING M18 BARE TOOL



\$232⁹⁹
M18™ Cordless 2-Speed Grease Gun (Tool Only)
MIL 264620



\$149⁹⁹
M18™ ROVER™ Dual Power Flood Light (Tool Only)
MIL 236620^{SS}

GET THIS FREE



M18™ REDLITHIUM™ CP2.0 Battery
MIL 48111820
\$100 VALUE

PURCHASE A QUALIFYING IMPACT SOCKET SET



\$159⁹⁹
16PC SHOCKWAVE IMPACT DUTY™ Socket 1/2" Drive Metric PACKOUT™ Set (49666803)



\$159⁹⁹
15PC SHOCKWAVE IMPACT DUTY™ Socket 1/2" Drive SAE PACKOUT™ Set (49666802)

GET THIS FREE



3PC SHOCKWAVE IMPACT DUTY™ 1/2" Drive Extension Set
MIL 49666715
\$67 VALUE

PURCHASE QUALIFYING M18 OUTDOOR POWER EQUIPMENT



\$330⁹⁹
M18 FUEL™ 16" Chainsaw (Tool Only)
MIL 272720



\$329⁹⁹
M18 FUEL™ String Trimmer Kit w/ QUIK-LOK™
MIL 282521ST



\$353⁹⁹
M18 FUEL™ Blower Kit
MIL 272421HD

GET THIS FREE



M18™ REDLITHIUM™ HIGH OUTPUT™ XC6.0 Battery
MIL 48111865
\$82 VALUE

PURCHASE A QUALIFYING M18 BATTERY 2-PACK



\$282⁹⁹
M18™ REDLITHIUM™ HIGH OUTPUT™ XC6.0 Battery - 2PK
MIL 48111862

YOUR CHOICE FREE



M18 FUEL™ HACKZALL® (Tool Only)
MIL 271920
\$171 VALUE



M18 FUEL™ 4-1/2" / 5" Grinder Paddle Switch, No-Lock (Tool Only)
MIL 288020
\$199 VALUE



M18™ Inflator (Tool Only)
MIL 284820
\$180 VALUE



M18 FUEL™ 3/8" Compact Impact Wrench w/ Friction Ring (Tool Only)
MIL 285420
\$233 VALUE



M18™ Blower (Tool Only)
MIL 301720^{SS}
\$179 VALUE

SPECIAL PRICING

Was ~~\$149⁹⁹~~
Now **\$109⁹⁹**
43PC SHOCKWAVE IMPACT DUTY™ 3/8" Drive SAE & Metric Deep 6-Point Socket Set
MIL 49667009



Was ~~\$209⁹⁹~~
Now **\$189**
29PC SHOCKWAVE IMPACT DUTY™ 1/2" Drive SAE & Metric Deep 6-Point Socket Set
MIL 49667016



Was ~~\$289⁹⁹~~
Now **\$199⁹⁹**
15PC SHOCKWAVE IMPACT DUTY™ RED HELIX™ Titanium Drill Bit Set
MIL 48894670^{SS}





PRO-LOGIX BATTERY CHARGERS, MAINTAINERS AND POWER SUPPLIES

Model No. SOR PL6800^{DS}
12 Volt Reflashing 100A Power Supply
and 100/40/10A Battery Charger



Was \$1070
Now \$699

Requires
20 Amp Service

Model No. SOR PL6100
12 Volt Reflashing 100A Power Supply
and 60/40/10A Battery Charger



Was \$894⁹⁹
Now \$599

Requires
20 Amp Service



PL6100 and PL6800 Feature: 13' Cable Reach, Manages Sulfated Batteries and Precise Voltage Control.



SOR PL3740
12V WHEEL CHARGER

Was \$349
Now \$299

- Stable Power Mode + Engine Start
- 40/15/5/225A
- Analog Knob Controls
- Timed charge routines
- Automatic Charge Mode
- Ships fully assembled
- 2-Year Limited Warranty



PL3740 Control Panel

Properly charges a wide variety of battery types such as: Flooded, AGM, Spiral, Deep Cycle and Marine batteries



SOR 1002
1.5 AMP
12V BATTERY CHARGER

- 12V Operation
- ETL Approved
- LED Display

Was \$42⁹⁹
Now \$39⁹⁹

LITHIUM
LiFePO4
COMPATIBLE



SOR PL2112^{DS}
1.0 AMP
12V BATTERY CHARGER

- 12V Operation
- Mounts to Battery
- ETL Approved

Was \$44⁹⁹
Now \$37⁹⁹

BOOSTER PAC, TRUCK PAC AND JUMP-N-CARRY JUMP STARTERS



SOR ES5000
12V JUMP STARTER

- 1500 Peak Amps
- 43" Cable Length
- #4 Gauge Cable

Was \$224⁹⁹
Now \$179



SOR ES2500
12V JUMP STARTER

- 1100 Peak Amps
- 21" Cable Length
- #4 Gauge Cable

Was \$193⁹⁹
Now \$149



JUMP STARTS
8.0L GAS
6.0L Diesel



NEW DESIGN
JUMP STARTS
10.0L
Gas and Diesel

SOR JNC325 LITHIUM
12 VOLT JUMP STARTER

- 450 Start Assist Amps
- 74Wh Capacity
- Starts Most V8 Vehicles

Was \$257⁹⁹
Now \$179

SOR JNC345 LITHIUM
12 VOLT JUMP STARTER

- 550 Start Assist Amps
- 89Wh Capacity
- USB-C Charging Port

Was \$334⁹⁹
Now \$249



SOR JNC345

LIGHT-N-CARRY TORCH LIGHTS

SOR LNC312
120 LUMEN

Was \$32⁹⁹
Now \$27⁹⁹

- Magnetic ON/OFF Power Button
- 120 Max Lumen
- Twist Action Zoom
- Protected MicroUSB Charging Port
- Charging Status LED Indicator
- USB/Micro USB Braided Charging Cord
- Dimmer Function

SOR LNC330
400 LUMEN

Was \$48⁹⁹
Now \$39⁹⁹

- 400 Max Lumen COB Beam
- 350 Max Lumen LED Focus Beam
- Pull Action Zoom
- Emergency Hazard Flare
- Magnetic Base
- USB/Micro USB Braided Charging Cord
- Dimmer Function

SOR LNC375
750 LUMEN

Was \$78⁹⁹
Now \$59⁹⁹

- 750 Max Lumen Focus Beam
- Pull Action Zoom
- Protected MicroUSB Charging Port
- Wireless Charging Base
- Charging Status LED Indicator
- USB/Micro USB Braided Charging Cord
- Dimmer Function

COB LED RECHARGEABLE WORK LIGHTS

SOR LNC1541
500 LUMEN

Was \$57⁹⁹
Now \$44⁹⁹

- 180° Swivel Action
- Micro-USB Charging
- Grip-Tech Housing
- 4 Hour Run Time
- IP54 Water Resistance
- Magnet Mounting

SOR LNCMINI
110 LUMEN

Was \$24⁹⁹
Now \$19⁹⁹



CHARGE IT! WHEEL CHARGERS AND BATTERY CHARGERS - GREAT FOR DIY

SOR 4735
12V, 40/10/2/200A

- Automatic Operation
- 40A High 12V Rate
- 10A Medium 12V Rate
- 2A Low 12V Rate
- 200A 12V Engine Start
- Digital Display
- Full Size Clamps
- Reverse Polarity

Was \$261⁹⁹
Now \$179

SOR 4745
12/24V, 40/20/2/230A

- Automatic Operation
- 40A High 12V Rate
- 20A Medium 12V Rate
- 2A Low 12V Rate
- 20A High 24V Rate
- 2A Low 24V Rate
- 230A 12V Engine Start
- Digital Display

Was \$334⁹⁹
Now \$285

12/24V
OPERATION

SOR 4512
12V, 12/6/2A

Was \$72⁹⁹
Now \$63⁹⁹

- Automatic Operation
- Digital Display
- Smart Clamp Technology

SOR 4520
12V, 20/10/2A

Was \$86⁹⁹
Now \$74⁹⁹

- Digital Display
- Maintenance Mode
- Forced Start

20 AMP

SOR 4501 - 12V, 800mA Battery Charger Was \$32⁹⁹ \$29.99
SOR 4502 - 6/12V, 2.5A Battery Charger Was \$40⁹⁹ \$34.99
SOR 4506 - 6/12V, 6/2A Battery Charger Was \$51⁹⁹ \$44.99

*DS = Special Order Item. Contact NAPA representative for lead time







Was ~~\$289~~
Now **\$159**

Lithium Automotive 12V 2000A Portable Jump Starter and Power Bank
NBC SL1651^{MS}



Was ~~\$275⁹⁹~~
Now **\$229⁹⁹**

EV Electric Vehicle Charger
NBC SC1455



Was ~~\$299~~
Now **\$239**

DSR Schumacher DSR140 200/50/25/10 Amp 12/24V Manual Wheel Charger
NBC DSR140^{MS}



Was ~~\$299~~
Now **\$249⁹⁹**

DSR ProSeries Automotive 6-Volt/12-Volt 225-Amp Manual Wheel Battery Charger And Jump Starter
NBC DSR139^{MS}



Was ~~\$354~~
Now **\$269**

DSR ProSeries Automotive 12-Volt 4000 Peak Amp Lithium Jump Starter And Portable Power Station
NBC DSR164^{MS}



by 

Since 1976

DHC[®] BATTERY TESTERS



Was ~~\$373⁹⁹~~
Now **\$299**

DHC CBT2000

- 6/12V Battery Test up to 2000 CCA
- 12/24V Cranking / Charging System Test
- Tests All Battery Types Including Start-Stop AGM & EFB Batteries
- Thermal Printer



Was ~~\$481⁹⁹~~
Now **\$399**

DHC CBT3000

- 6/12V Battery Test up to 3000 CCA
- 12/24V Cranking / Charging System Test
- Tests All Battery Types Including Start-Stop AGM & EFB Batteries
- Thermal Printer



Was ~~\$2845⁹⁹~~
Now **\$2399**

DHC BT2300PLUS^{DS}

- 3-in-1 Battery Tester, Fast Charger, Power Supply
- 12/24V Cranking / Charging System Test
- Wi-Fi Enabled Cloud Service
- "SET-N-GO" Automatic Testing/Charging Procedure
- Supports Optional Amp Clamp and Volt Probe

PREVENTATIVE MAINTENANCE IS THE KEY TO PROFITS

DON'T MISS OUT
ASK US HOW THESE 4 MACHINES CAN UNLOCK MASSIVE SHOP PROFITS

Amazing Deals with NAPA Real Deals



Maximize your shop's profitability with:

- Premium parts and tools at discounted prices.
- Special programs for financial flexibility.
- Personalized support from your NAPA representative.

NAPA understands the importance of financial flexibility. Contact your NAPA representative now and discover the incredible deals available through Real Deals and ask about special finance programs that allow you to enjoy profits before paying.

SOLTEC offers a COMPLETE line of preventative maintenance chemicals and equipment.



AUTEL[®]

MAXICHARGER™ HOME

All Home Models

- Compatible with all EV and Hybrid Plug-in Vehicles
- 25ft long Universal (J1772) Charging Cable
- Contemporary Design, Dark Gray
- For residential use only
- Autel Charge app enables remote start, stop, monitoring and scheduling
- Specially designed for Indoor or Outdoor use
- Wi-Fi/Bluetooth/ Ethernet
- Three year limited warranty

Separate Holster \$559.99

- Part #ATD MC40AP14S^{MS}**
- Adjustable charging up to 40 Amps
 - NEMA 14-50 Plug

- Part #ATD MC40AP6S^{MS}**
- Adjustable charging up to 40 Amps
 - NEMA 6-50 Plug

- Part #ATD MC50AHS^{MS}**
- Adjustable charging up to 50 Amps
 - Hardwire Installation



In-Body Holster

Part #ATD MC40AP14I^{MS}

- Adjustable charging up to 40 Amps
- NEMA 14-50 Plug

Part #ATD MC40AP6I^{MS}

- Adjustable charging up to 40 Amps
- NEMA 6-50 Plug

Part #ATD MC50AHI^{MS}

- Adjustable charging up to 50 Amps
- Hardwire Installation

\$559.99

MAXICHARGER™ COMMERCIAL

MONETIZE YOUR CHARGING SERVICES

\$120 for 12 mos

Part #ATD MCC50AHI^{MS} \$1190

- Compatible with all EV and Hybrid Plug-in Vehicles
- 25ft long Universal (J1772) Charging Cable
- Hardwire Installation
- Adjustable charging up to 50 Amps
- In-body holster
- For commercial use
- Specially designed for Indoor or Outdoor use
- Interactive LCD touchscreen
- RFID Reader
- Bluetooth, Wi-Fi, Ethernet, 4G
- Three year limited warranty



Have Tools & Equipment Product Questions? Scan Here

AUTEL MAXISYS

ALIGNMENT WITHOUT LIMITS

DIAGNOSTICS + DIGITAL INSPECTION + ALIGNMENT + ADAS CALIBRATION



MAXISYS IA900 FOUR-WHEEL ALIGNMENT & ADAS CALIBRATION SYSTEM

IA900WA All Systems ADAS Package \$39970 \$888 for 60 mos

Part #ATD IA900AST^{DS}
 • All Systems ADAS Calibration Target & Equipment Package with ULTRAADAS Tablet

IA900WA LDW ADAS Package \$28150 \$626 for 60 mos

Part #ATD IA900LDWT^{DS}
 • LDW ADAS Calibration Target & Equipment Package with ULTRAADAS Tablet

IA900WA ADAS & Wheel Alignment Package \$23220 \$516 for 60 mos

Part #ATD IA900WAT^{DS}
 • ADAS & Wheel Alignment System Package including IA900 frame and ULTRAADAS Tablet



ATD AULS14ALOR1T, ATD AULS12ALOR1T, ATD AULS14ALOR1, ATD AULS12ALOR1

ADAS BAY MAX 12K LIFT \$41010

Part #ATD AULS12ALOR1T^{DS} \$912 for 60 mos

- Flush-mounted Hydraulic Alignment Scissor 12K Lift with Floor Lift Table
- Specially Designed Alignment Lift that Enables ADAS Calibrations to be Performed Within Bay Space
- Stainless Steel Front Radius Plates and Rear Slip Plates
- Includes Two 6K Capacity Jacking Beams
- Front & Rear-Opening Runways with Flip Down Wheel Stops

ALIGNMENT 12K LIFT \$37010 \$823 for 60 mos

Part #ATD AULS12ALOR1^{DS}

- Flush-mounted Hydraulic Alignment Scissor Lift
- 12,000 Pound Lifting Capacity
- Stainless Steel Front Radius Plates and Rear Slip Plates
- Includes Two 6K Capacity Jacking Beams
- Front & Rear-opening Runways with Flip Down Wheel Stops

ADAS BAY MAX LIFT ADAS CALIBRATION. SAFER ALIGNMENTS. ONE MAXIMIZED BAY.

ADAS BAY MAX 14K LIFT \$43010

Part #ATD AULS14ALOR1T^{DS} \$956 for 60 mos

- 14,000 Pound Lifting Capacity
- Includes Two 7K Capacity Jacking Beams

ALIGNMENT 14K LIFT \$39010 \$867 for 60 mos

Part #ATD AULS14ALOR1^{DS}

- 14,000 Pound Lifting Capacity
- Includes Two 7K Capacity Jacking Beams

UPGRADE YOUR LDW PACKAGE



RADAR CALIBRATION PACKAGE \$4110

Part #ATD ADASRAD1^{DS} \$113 for 60 mos

- Radar calibration component package
- Includes Adaptive Cruise Control adapter, Doppler radar box, Continental radar plate, Corner Reflector
- Enables calibration of radar-based safety systems including ACC and Blind Spot Detection
- Compatible with Autel Standard Calibration Frame



L-shaped Bracket

Five Line Laser

Laser Reflector



Laser Assist Mirror

Two Line Laser

Plumb Bob

ADAS ACCESSORY PACKAGE \$934.99

Part #ATD ADASACCESSOR^{DS}

- Includes Five and Two-Line Lasers and Plumb Bob, Laser Reflector and Laser Assist Mirror, L-Shaped Bracket
- Enable Quicker Identification of Vehicle Center Line and Positioning of Frame From Vehicle
- Enables More Efficient Calibration of Many ADAS Systems Including ACC, BSM, AVM and Some LDW
- Compatible with Autel Standard Calibration Frame



500-17 Tire Clamps \$1730 \$174 for 12 mos

Part #ATD 50017^{DS}

- In contrast to standard clamps, tire clamps attach to tires rather than to rims, eliminating potential rim damage.

ADAS Lane Departure Warning \$9660 \$234 for 60 mos

Part #ATD LDW30^{DS}

- Standard ADAS calibration frame with target board holder
- Includes IA800 optical positioning system for rapid vehicle to target positioning
- Includes LDW targets and patterns for Honda, Genesis, VW, Mercedes, Hyundai, Kia
- Includes LDW targets and patterns for Nissan, Infiniti, Mazda, Mitsubishi, Subaru, Toyota, Lexus

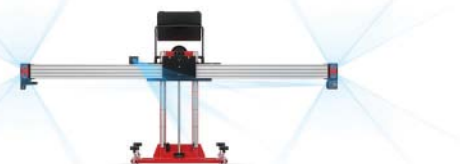

AUTEL MAXISYS



MSULTRA shown; 12.9" display, split-screen functions, docking station included

MaxiSYS[®] DIAGNOSTIC SOLUTIONS

- Most comprehensive vehicle coverage in aftermarket scan tool
- Dynamic topology module mapping for supported vehicles combined with Intelligent Diagnostics feature that guides the technician from code to repair to test with detailed repair information and illustrations.
- Octacore processor and 128GB-256GB memory
- Advanced VCMi including 4-channel scope on MSULTRA and MS919
- Programming and flashing with included J2534 pass-through box (with OE subscription)
- Remote Expert allows for remote programming, flashing, and reporting capabilities
- Easily expandable ADAS, Wheel Alignment, and EV diagnostics

Access REMOTE EXPERT from your XLINK, MaxiSYS Ultra, MS919 or MS909. Get live help from expert technicians for programming, diagnostics & more.

AUTEL MAXIFLASH

MaxiFLASH[®] XLINK \$1400 \$141 for 12 mos

Part #ATD XLINK^{DS}

- Enhanced Vehicle Communication Interface for quicker communication and systems access
- J2534-pass thru programmer to update modules with OE software
- Supports latest vehicle communications protocols
- Enables on-site and remote module programming



MaxiSYS[®] ULTRA

Part #ATD MSULTRA^{DS}

\$5999.99

\$168 for 60 mos

MaxiSYS[®] MS919

Part #ATD MS919^{DS}

\$4745

\$133 for 60 mos

MaxiSYS[®] MS909

Part #ATD MS909^{DS}

\$3795

\$106 for 60 mos

MaxiSYS[®] MS906PRO \$1595 \$161 for 12 mos

Part #ATD MS906PRO^{DS}

- 8-inch Wireless Touchscreen tablet \ with Bluetooth-enabled MaxiSYS VCI200
- Octa-Core Processor/128 GB memory / 4 GB RAM
- Performs all system scan with ADAS identification/ Customizable Pre & Post scans
- Read/Erase Codes, View Freeze Frame and Live Data



AUTEL MAXICHECK

MaxiCHECK[®] MX900 \$504.99

Part #ATD MX900^{DS}

- Compatible with U.S., Asian, and European Vehicles, 1996 and Newer

- Read and Erase Codes, View and Graph Live Data, View Freeze Frame Data
- Perform Bi-Directional Active Tests and Special Functions



AUTEL MAXISYS CV

MaxiSYS[®] MS909CV \$5450 \$133 for 60 mos

Part #ATD MS909CV^{DS}

- Class 1-9 Heavy Duty Vehicles
- Fast AutoScan, VINScan & AutoVIN
- Battery Testing & ADAS Capable
- Topology Mapping on Select Vehicles
- New off-highway engine diagnostic coverage for construction and agricultural machinery
- Bi-directional engine controls for John Deere



Get live help from expert technicians for programming, diagnostics & more with Remote Expert.



COMPLETE SOLUTION

AUTEL MAXITPMS

NEW



MaxiTPMS® TS900 \$799.99
Part #ATD TS900^{OS}

- Compatible with Autel BLE Sensor for Tesla vehicles and other vehicles using Bluetooth Low Energy (BLE) TPMS sensors
- Program Autel MX-Sensors
- Bi-directional controls
- Active Tests and Special Functions
- 40+ service functions

NEW



MaxiTPMS® MX-Sensor BLE \$68.99
Part #ATD 300100

TESLA-READY

- Pre-programmed Bluetooth TPMS sensors for Tesla 3/Y/S/X models
- Tesla-ready. Just Fit and Go
- Future-proof: programmable with Autel TPMS tools for the latest BLE-equipped vehicles

AUTEL MX-SENSOR PROGRAMMING + MORE



MaxiSYS® MS906PRO-TS \$1995
Part #ATD MS906PRO-TS^{OS}

- TPMS & Service Functions **\$109^{per 24 mos}**
- Advanced Diagnostics with Coding and Adaptations
- Bi-Directional / ADAS-Capable
- All System AutoSCAN with ADAS Identification

AUTEL TPMS TOOL & SENSOR KITS

MaxiTPMS® ITS600 \$462.99
Part #ATD ITS600^{OS}

- Compatible with Autel BLE Sensor
- TPMS Service + 4 Common Service Resets
- Activate, Read & Relearn All Known Sensors
- Program Autel MX-Sensors

MaxiTPMS® ITS600K8 Kit \$699.99
Part #ATD 700130^{OS}

- All The Same Features As The ITS600
- Also includes 8 1-Sensors



UNIVERSAL 1-SENSOR



MaxiTPMS® 1-Sensor \$29.99
Part #ATD 1SENSOR

- Program to Replace 99% of OE Sensors On The Road
- Combined Frequency: 315MHz & 433MHz
- Interchangeable Valve Stems
- Rubber Valve Stem Included
- Sold Individually



MaxiTPMS® 1-SensorM \$29.99
Part #ATD 1SENSORM

- All Same Features as 1-Sensor
- Aluminum Valve Stem Included
- Sold Individually



MaxiTPMS® TS508WF8 Kit \$419.99
Part #ATD TS508WFK^{OS}

- TS508WF Kit with 8 1-Sensors
- Updated software via Wi-Fi
- Program Autel 1-Sensors
- Exclusive TPMS Status Screen

MaxiTPMS® TS508WF4 Kit \$249.99
Part #ATD 700180^{OS}

- TS508WF Kit with 4 1-Sensors



MaxiTPMS® Adjustable Angle 1-Sensor \$25.99
Part #ATD 300030^{OS}

- 15° Valve Stem Flexibility Fits a Wider Variety of Vehicles
- Program to Replace 99% of OE Sensors
- Combined Frequency: 315MHz & 433MHz
- Rubber Included • Sold Individually



MaxiTPMS® Adjustable Angle 1-SensorM \$25.99
Part #ATD 300020^{OS}

- All Same Features As Adjustable Angle 1-Sensor
- Aluminum Valve Stem Included

TIRE HEALTH ACCESSORIES



MaxiTPMS® TBE200 \$449.99
Part #ATD TBE200^{OS}

- Tire Tread and Brake Disc Wear Examiner
- Laser-Enabled; No Need to Remove Tire
- Full Color Touchscreen Display Illustrates Wear
- 2 Cameras to Document Tire Damage
- Scan Tire Identification Number (TIN)



MX-SENSOR BULK PACKS



MaxiTPMS® 1-Sensor 20 Packs \$445.99
Part #ATD 300010

- Package of 20 1-Sensors with Rubber Valves

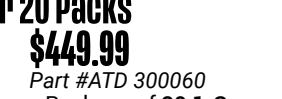

MaxiTPMS® 1-SensorM 20 Packs \$449.99
Part #ATD 300060

- Package of 20 1-Sensors with Aluminum Valves

STOCK UP ON 1-SENSORS



MaxiTPMS® 1-Sensor 240 Bulk Pack \$6970 \$169^{per 60 mos}
Part #ATD 300050

- Package of 240 Autel 1-Sensors with Rubber Valve Stems

AUTEL MAXIBAS

MaxiBAS® BT506 \$195.99
Part #ATD BT506^{OS}

- Use with Smartphone or other Smart Device
- Support In-vehicle and Out-of-Vehicle Testing of Passenger Vehicle Batteries
- Test 6- and 12-volt Batteries: 100 - 2000 CCA
- Test 12- and 24- Cranking/Charging Systems
- Test Flooded, AGM, AGM Spiral, EFB & GEL Batteries
- Compatible with CCA, CA, SAE, EN, IEC, DIN, JIS & MCA



MaxiBAS® BT608 \$599.99
Part #ATD BT608^{OS}

- 5.5" Tablet/Android 9.0/Wi-Fi Updates
- All Same Features as BT506 Plus
- Adaptive Conductance Technology: Detects Battery Capacity Reducing Misdiagnosis
- Auto Battery Reset/Print Test Reports Via Built-in Thermal Printer
- AutoSCAN/VINScan for Quick Vehicle Identification & Battery Specifications



AUTEL MAXIIM

MaxiIM® KM100 \$544.99
Part #ATD KM100^{OS}

- Advanced key and immobilizer with 2 IKEYS
- Program Autel's IKEY universal keys as smart key replacement for more than 700 vehicles
- 60sec Key generation, Easy key button customization
- Chip Read/Write, Cloning and Frequency Detection
- Extensive IMMO Key programming coverage



AUTEL®



**LAUNCH
TECH USA**
CREATE • CHANGE

GLOBAL LEADER IN DIAGNOSTIC SOLUTIONS



X-431 Throttle III
LAN 301180833^{DS}
Was ~~\$7310~~ Now ~~\$5847~~
\$140 for 60 mos.

One is Enough with our X-431 Throttle III which is a Wi-Fi enabled and super advanced scan tool with upgraded all-in-one Smartlink VCI. The Throttle III supports CANFD/DoIP/J2534 and more.



X-431 Torque 5
LAN 301190794^{DS}
Was ~~\$3750~~ Now ~~\$2996~~
\$113 for 36 mos.

X-431 Torque 5 is an advanced intelligent vehicle diagnostic device developed based on the Android 10.0 system. The X-431 Torque 5 comes with the 2-channel oscilloscope, and supports CANFD/DOIP diagnostic protocols. It also features Modules for Battery Testing, Advanced Driver Assistance Systems(ADAS), IMMO Diagnostics and more.



X-431 Torque AutoHD Pro
LAN 301190908^{DS}
Was ~~\$5495~~ Now ~~\$5496~~
\$125 for 60 mos.

The X-431 Torque Auto HD PRO is an all-in-one automotive and HD scan tool. This unit has bigger storage, a high-endurance battery and wide coverage in both automotive and HD.



X-431 Turbo III
LAN 321195201^{DS}
Was ~~\$2140~~ Now ~~\$1596~~
\$158 for 12 mos.

Launch X-431 Turbo III is a smart diagnostic system that supports full-system fault diagnosis. Additionally, it is capable of performing battery detection and IMMO Functions with optional add-on module.



X-431 Torque Link
LAN 321195101^{DS}
Was ~~\$3250~~ Now ~~\$2596~~
\$101 for 36 mos.

X-431 Torque LINK supports full system fault diagnosis, with functions such as Read DTCs, Clear DTCs, Read Data stream, Special function, Actuation test, Coding, Matching and more. It supports CANFD/DOIP diagnosis protocol.



VSP-808
LAN 307110019^{DS}
Was ~~\$2250~~ Now ~~\$17999~~

The Videoscope 808 is the perfect tool for viewing and capturing video and still images of hard-to-reach areas. View real-time internal structure of the vehicle on the 4.3" TFT display.



BST-360
LAN 301180832^{DS}
Was ~~\$1120~~ Now ~~\$9999~~

BST-360 is suitable for technicians and on the go consumers and is an excellent option for the repair shops to turn your scan tool into battery test functionality.



TSAP-3
LAN 302020529^{DS}
Was ~~\$569~~ Now ~~\$47995~~

TSAP-3 is designed to activate, read, and service major OEM and aftermarket sensors. It is capable of updating wirelessly via Wi-Fi, placard change and OBD II relearns.

TOPDON®

BEST WARRANTY & CUSTOMER SUPPORT IN THE INDUSTRY

OE-LEVEL DIAGNOSTICS

Phoenix Max

13.3" OE-Level Scan Tool

- 4-Channel Oscilloscope
- Cloud-Based Programming and Online Coding
- 41+ Maintenance Services
- Charging Dock
- 2 Years of Software Updates



Was ~~\$4509~~ Now ~~\$4284~~ **\$118** for 60 mos. TDN PXMAX^{DS}

Phoenix Smart

10.1" OE-Level Scan Tool

Supports J2534, DoIP, CAN FD, D-PDU, and RP1210 Protocols

Cloud-Based Programming & Online Coding

2 Years of Software Updates



Was ~~\$2309~~ Now ~~\$2194~~ **\$120** for 24 mos. TDN PXSMART^{DS}

Phoenix Lite 2

8" OE-Level Scan Tool

35+ Maintenance Services
Bi-Directional Control
ECU Coding Function

2 Years of Software Updates



Was ~~\$799~~ Now ~~\$759.05~~ TDN PXLITE2^{DS}

THERMAL IMAGING

TC001

Thermal Imaging Camera for Android Devices

Clear Thermal Image:
256*192 Pixels
Temperature Resolution
Down to 0.1 °F
Smart Temperature Alert



Was ~~\$224~~ Now ~~\$212.80~~ TDN TC001^{DS}

TC002

Thermal Imaging Camera for iOS Devices

Clear Thermal Image:
256*192 Pixels
Temperature Resolution
Down to 0.1 °F
Designed For iPhone And iPad



Was ~~\$234~~ Now ~~\$222.30~~ TDN TC002^{DS}

TC005

Handheld Thermal Imaging Camera

Resolution: 256*192 Pixels
Free Image Analysis
Dual-Camera with Visible Light Lens



Was ~~\$339~~ Now ~~\$322.05~~ TDN TC005^{DS}

KEY PROGRAMMING

T-Ninja Pro

8" Tablet Key Programming Tool

Read, Write, And Generate Keys
Covers 50+ Mainstream Car Brands
1 Year of Updates



Was ~~\$499~~ Now ~~\$474.05~~ TDN TNINJAPRO^{DS}

*DS = Special Order Item. Contact NAPA representative for lead time





\$1740
Drew Tech
CARDAQ-PLUS3 KIT
OPS CDP3KIT^{MS}



\$3000
Drew Tech CarDAQ and
RAP w IVS360 Support Svc
OPS CARDAQPRO360^{MS}



Was ~~\$1300~~
Now **\$1170**
Open Android Scn Tool
CND CPRO^{MS}



Was ~~\$999~~
Now **\$899¹⁰**
Code Scanner DPF Tool
CND HDCODEPRO^{MS}



Was ~~\$3860~~
Now **\$3474**
HDpro Android
Tab-hd Ap
CND HDPROTAB^{MS}



Was ~~\$304⁹⁹~~
Now **\$274⁴⁹**
HD Code
Reader-CAT
CND HDCODEII^{MS}



INNOVA IDEAL FOR PRO AUTOMOTIVE DIAGNOSTICS

SDS SMART DIAGNOSTIC SYSTEM



INNOVA[®] OE-LEVEL
DIAGNOSTIC TABLET **\$314.99**
BK SDS50

SDS-Tech

- All Systems Scan
- OEM Level DTC's + Live Data
- Bi-Directional + Active Tests



INNOVA[®] OE-LEVEL
DIAGNOSTIC TABLET **\$237.99**
BK SDS43

SDS-Inspector

- Emissions System Diagnostics
- ABS System Service
- Powertrain, Body + Chassis Diagnostics



POWERED BY
REPAIR SOLUTIONS PRO

**Get Fixes.
Repair Tips.
Share Reports.**

RepairSolutionsPRO[™] is an app-based service created to help professional technicians simplify and augment their vehicle diagnostic process.

Finding Fixes Has Never Been Easier
Seamlessly switch between your devices to maximize efficiency and access your reports anytime, anywhere.

Free access. No subscriptions.



POWER PROBE[®]

SPECIAL DEALS



Was ~~\$129~~
Now **\$120**
Power Probe[®] III Circuit Tester
BK PP3CSRED



Was ~~\$184~~
Now **\$175**
Intelligent short/open finder
BK PPECT3000



\$349
Maestro Red
BK PPTM01AS



Was ~~\$199~~
Now **\$189**
Power Probe[®] III w/Lead Set Kit
BK PP3LS01



Was ~~\$379~~
Now **\$360**
Power Probe[®] 4 Master Kit
BK PPKIT04

Invented for Life

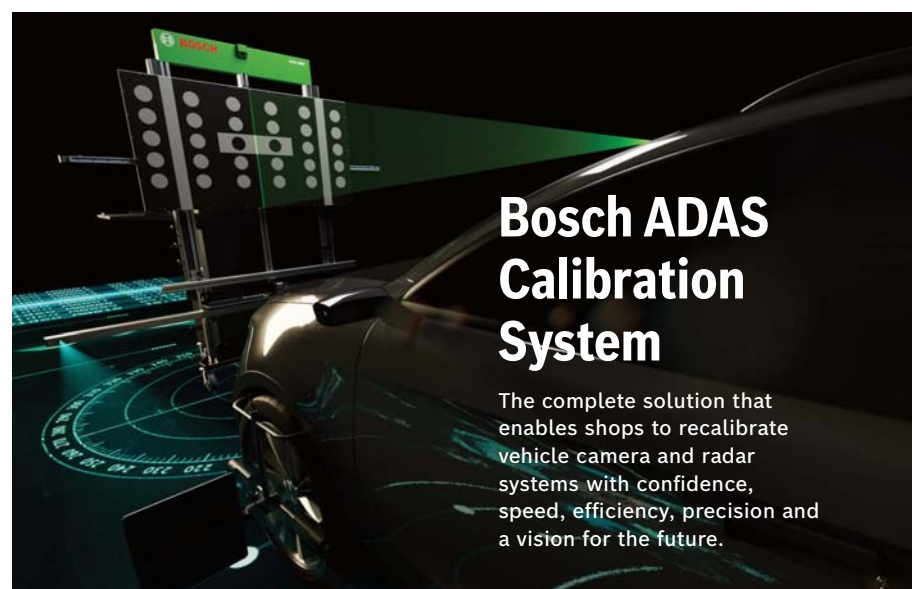

Bosch ADAS Calibration System

The complete solution that enables shops to recalibrate vehicle camera and radar systems with confidence, speed, efficiency, precision and a vision for the future.



Co-developing the next generation of vehicle sensors with major OEMs means your ADAS equipment is ready for the vehicles of today and of the future.

Bosch DAS 3000 ADAS Calibration System

Includes Bosch ADS 625X
Call Store For Promo Pricing
BSD DAS30001^{MS}



You can count on Bosch, the global leader in diagnostics, to deliver a full range of solutions that work together to make your service process precise and simple.

ADAS Calibration Kit

Targets and calibration fixture kit works with user's existing 625X scan tool
Call Store For Promo Pricing
BSD DAS30002^{MS}

boschdiagnostics.com/adas

Solutions for every job.

Have Tools & Equipment Product Questions? Scan Here



CARLYLE TOOLS by NAPA

1500 SERIES

24" BOX DEPTH
16GA FRAME
125 LB PER SLIDE

10 YEAR LIMITED WARRANTY



24" DEPTH
POWER BANKS

18GA DRAWERS
125 LB PER SLIDE

FULL EXTENSION BALL-BEARING SLIDES

LIFT LOCK DRAWER DESIGN

16GA FRAME

770 LB HEAVY DUTY LOCKING CASTERS

UNMATCHED QUALITY AND DURABILITY

AVAILABLE COLORS:



The 1500 Series combines the perfect blend of drawer storage capacity and quality. It is constructed with heavier, 16-gauge steel frame and 18-gauge steel drawers. This toolbox series boasts a 24" depth that provides more usable storage space and is strong enough to support 3,080 lbs



41"

54"

72"

Part #	Color/Finish	Product	Price
CHT 150041CBK	Jet Black	Top Chest 4 Drawers Lift Top: 3.5" D	\$989
CHT 150041CBL	Reflex Blue	40 1/2" W x 23 1/2" D x 22" H	
CHT 150041CGN	Electric Green	Total Cu. In.: 12,560	
CHT 150041BBK	Jet Black	Bottom Chest 7 Drawers	\$1399
CHT 150041BBL	Reflex Blue	41" W x 24" D x 40" H	
CHT 150041BGN	Electric Green	Total Cu. In.: 17,628	
CHT 150041ST	Stainless Steel	Work Surface	\$159
CHT 150041WT	Butcher Block	41" W x 24" D x 1.5" H	\$199

Part #	Color/Finish	Product	Price
CHT 150054CBK	Jet Black	Top Chest 8 Drawers Lift Top: 3.5" D	\$1389
CHT 150054CBL	Reflex Blue	53 1/2" W x 23 1/2" D x 22" H	
CHT 150054CGN	Electric Green	Total Cu. In.: 16,250	
CHT 150054BBK	Jet Black	Bottom Chest 10 Drawers	\$1800
CHT 150054BBL	Reflex Blue	54" W x 24" D x 40" H	
CHT 150054BGN	Electric Green	Total Cu. In.: 21,861	
CHT 150054ST	Stainless Steel	Work Surface	\$209
CHT 150054WT	Butcher Block	54" W x 24" D x 1.5" H	\$249

Part #	Color/Finish	Product	Price
CHT 150072CBK	Jet Black	Top Chest 12 Drawers Lift Top: 3.5" D	\$1679
CHT 150072CBL	Reflex Blue	72 1/2" W x 23 1/2" D x 22" H	
CHT 150072CGN	Electric Green	Total Cu. In.: 21,659	
CHT 150072BBK	Jet Black	Bottom Chest 14 Drawers	\$2500
CHT 150072BBL	Reflex Blue	72" W x 24" D x 40" H	
CHT 150072BGN	Electric Green	Total Cu. In.: 30,103	
CHT 150072ST	Stainless Steel	Work Surface	\$279
CHT 150072WT	Butcher Block	41" W x 24" D x 1.5" H	\$349

2500 SERIES

26" BOX DEPTH
14GA FRAME
165 LB PER SLIDE

LIMITED LIFETIME WARRANTY



26" DEPTH
POWER BANKS

18GA DRAWERS
165 LB PER SLIDE

FULL EXTENSION BALL-BEARING SLIDES

LIFT LOCK DRAWER DESIGN

14GA FRAME

770 LB HEAVY DUTY LOCKING CASTERS

UNMATCHED QUALITY AND DURABILITY

AVAILABLE COLORS:



The 2500 Series was built to be a powerful workhorse offering uncompromising durability and space that will last a professional for a lifetime. Constructed with a 14-gauge steel frame and 18-gauge steel drawers the 2500 Series is 26" deep, providing more usable storage space. The 41" and 54" bottom are strong enough to support 3,080 lbs, while the 72" can support 4,620 lbs.



41"

54"

72"

Part #	Color/Finish	Product	Price
CHT 250041HBK	Jet Black	Hutch 41" W x 26" D x 25.3" H	\$1099
CHT 250041HBL	Reflex Blue	Total Cu. In.: 12,989	
CHT 250041CBK	Jet Black	Top Chest 5 Drawers	\$1549
CHT 250041CBL	Reflex Blue	41" W x 26" D x 25.3" H	
CHT 250041CBL	Reflex Blue	Total Cu. In.: 30,103	
CHT 250041BBK	Jet Black	Bottom Chest 6 Drawers	\$1900
CHT 250041BBL	Reflex Blue	41" W x 26" D x 25.3" H	
CHT 250041BBL	Reflex Blue	Total Cu. In.: 30,103	
CHT 250041ST	Stainless Steel	Work Surface	\$169
CHT 250041WT	Butcher Block	41" W x 26" D x 1.5" H	\$199

Part #	Color/Finish	Product	Price
CHT 250054HBK	Jet Black	Hutch 54" W x 26" D x 23.8" H	\$1399
CHT 250054HBL	Reflex Blue	Total Cu. In.: 17,489	
CHT 250054CBK	Jet Black	Top Chest 8 Drawers	\$1969
CHT 250054CBL	Reflex Blue	54" W x 26" D x 25.3" H	
CHT 250054CBL	Reflex Blue	Total Cu. In.: 30,103	
CHT 250054BBK	Jet Black	Bottom Chest 11 Drawers	\$2600
CHT 250054BBL	Reflex Blue	54" W x 26" D x 40" H	
CHT 250054BBL	Reflex Blue	Total Cu. In.: 30,103	
CHT 250054ST	Stainless Steel	Work Surface	\$225
CHT 250054WT	Butcher Block	54" W x 26" D x 1.5" H	\$275

Part #	Color/Finish	Product	Price
CHT 250072HBK	Jet Black	Hutch 72" W x 26" D x 23.8" H	\$1799
CHT 250072HBL	Reflex Blue	Total Cu. In.: 23,721	
CHT 250072CBK	Jet Black	Top Chest 10 Drawers	\$2349
CHT 250072CBL	Reflex Blue	72" W x 26" D x 25.3" H	
CHT 250072CBL	Reflex Blue	Total Cu. In.: 30,103	
CHT 250072BBK	Jet Black	Bottom Chest 12 Drawers	\$3499
CHT 250072BBL	Reflex Blue	72" W x 26" D x 40" H	
CHT 250072BBL	Reflex Blue	Total Cu. In.: 30,103	
CHT 250072ST	Stainless Steel	Work Surface	\$280
CHT 250072WT	Butcher Block	72" W x 26" D x 1.5" H	\$375



Homak RS

24" DEEP
100/200 LBS DRAWER CAPACITIES
NON-SLIP PVC DRAWER LINER
UV PROTECTIVE FINISH
LIFT LATCH DRAWER PULLS
CONSTRUCTED WITH 16 GAUGE STEEL FRAME



8 Drawer

9 Drawer

DEDICATED CORDLESS TOOL DRAWER WITH POWER STRIP
115V POWER STRIP INCLUDES 4 OUTLETS & 2 USB PORTS

120" \$7599

120" CTS Combo w/ Solid Backsplash
TSS BKCTS12001^{MS} Midnight Black
TSS BLCTS12001^{MS} Rally Sport Blue
TSS RDCTS12001^{MS} Fury Red

AVAILABLE IN
BK BL RD

A 120" \$7599

120" CTS Combo w/ Toolboard Backsplash
TSS BKCTS12002^{MS} Midnight Black
TSS BLCTS12002^{MS} Rally Sport Blue
TSS RDCTS12002^{MS} Fury Red

AVAILABLE IN
BK BL RD

B 44" \$1399

44" RS Pro 8 Drawer Flip Top Power Service Cart
TSS BK06044080^{MS} Midnight Black
TSS BL06044080^{MS} Rally Sport Blue
TSS RD06044080^{MS} Fury Red
TSS GR06044080^{MS} Battleship Gray

AVAILABLE IN
BK BL RD GR

C 44" \$1399

44" RS Pro 9 Drawer Flip Top Power Service Cart
TSS BK06044090^{MS} Midnight Black
TSS BL06044090^{MS} Rally Sport Blue
TSS RD06044090^{MS} Fury Red
TSS GR06044090^{MS} Battleship Gray

AVAILABLE IN
BK BL RD GR



D 72" \$1399

72" RS Pro 12 Drawer Top Chest w/ Power Strip
TSS BK02072120^{MS} Midnight Black
TSS BL02072120^{MS} Rally Sport Blue
TSS RD02072120^{MS} Fury Red
TSS LG02072120^{MS} Monster Green
TSS OG02072120^{MS} Competition Orange

AVAILABLE IN
BK BL RD LG OG

H 41" \$799

41" RS Pro 7 Drawer Top Chest w/ Power Strip
TSS BK02004173^{MS} Midnight Black
TSS BL02004173^{MS} Rally Sport Blue
TSS RD02004173^{MS} Fury Red
TSS LG02004173^{MS} Monster Green
TSS OG02004173^{MS} Competition Orange

AVAILABLE IN
BK BL RD LG OG



E 72" \$2100

72" RS Pro 16 Drawer Roller Cabinet
TSS BK04072160^{MS} Midnight Black
TSS BL04072160^{MS} Rally Sport Blue
TSS RD04072160^{MS} Fury Red
TSS LG04072160^{MS} Monster Green
TSS OG04072160^{MS} Competition Orange

AVAILABLE IN
BK BL RD LG OG

I 41" \$999

41" RS Pro 9 Drawer Roller Cabinet
TSS BK04004193^{MS} Midnight Black
TSS BL04004193^{MS} Rally Sport Blue
TSS RD04004193^{MS} Fury Red
TSS LG04004193^{MS} Monster Green
TSS OG04004193^{MS} Competition Orange

AVAILABLE IN
BK BL RD LG OG

F 54" \$1100

54" RS Pro 8 Drawer Top Chest w/ Power Strip
TSS BK02065800^{MS} Midnight Black
TSS BL02065800^{MS} Rally Sport Blue
TSS RD02065800^{MS} Fury Red
TSS LG02065800^{MS} Monster Green

AVAILABLE IN
BK BL RD LG OG



J 72" \$2299

72" RS Pro 16 Drawer Roller Cabinet w/ Stainless Steel Top 24" Depth
TSS BK04072164^{MS} Midnight Black
TSS BL04072164^{MS} Rally Sport Blue
TSS RD04072164^{MS} Fury Red
TSS LG04072164^{MS} Monster Green
TSS OG04072164^{MS} Competition Orange

AVAILABLE IN
BK BL RD LG OG



G 54" \$1599

54" RS Pro 10 Drawer Roller Cabinet
TSS BK04054010^{MS} Midnight Black
TSS BL04054010^{MS} Rally Sport Blue
TSS RD04054010^{MS} Fury Red
TSS LG04054010^{MS} Monster Green
TSS OG04054010^{MS} Competition Orange

AVAILABLE IN
BK BL RD LG OG



K 54" \$1699

54" RS Pro 10 Drawer Roller Cabinet w/ Stainless Steel Top 24" Depth
TSS BK04054014^{MS} Midnight Black
TSS BL04054014^{MS} Rally Sport Blue
TSS RD04054014^{MS} Fury Red
TSS LG04054014^{MS} Monster Green
TSS OG04054014^{MS} Competition Orange

AVAILABLE IN
BK BL RD LG OG



SCAN FOR ADDITIONAL PRODUCT INFORMATION



Have Tools & Equipment Product Questions? Scan Here

Carlyle® Air Compressors

With durability, performance, and solid cast iron cylinder, crankshaft, and valve plates, the Carlyle Air Compressor provides the strength that is required for everyday use. Deep-finned cylinder heads and coolers allow for unmatched heat dissipation. Balanced pistons and crankshaft mean smoother and quieter operation. Oversized main bearings and automotive-style replaceable rod bearings for a durable compressor pump. All units are 100% tested at full pressure.

ALL COMPRESSORS
FEATURE:

2 YEAR
WARRANTY

ASSEMBLED
IN USA

READY
TO RUN*

Learn more at: CarlyleAirCompressors.com
* NO START-UP KIT REQUIRED

SIMPLEX AIR COMPRESSORS

Simplex Air Compressors Are A Great Value For Small Shops And Home Use



Was \$1150 Now **\$1029** \$103 ^{for 12 mos.}
3.5 HP, 60 GALLON
1 Stage, 1 Phase, Vert.
115V, 7 ACFM @ 100 PSI, 135 Max PSI
NAC 894276VAT

Was \$1380 Now **\$1540** \$155 ^{for 12 mos.}
5 HP, 60 GALLON
2 Stage, 1 Phase, Vert.
208-230V, 15.5 ACFM @ 100 PSI, 175 Max PSI
NAC 89346VAT

Was \$2570 Now **\$2410** \$132 ^{for 24 mos.}
5 HP, 80 GALLON
2 Stage, 1 Phase, Vert.
208-230V, 18 ACFM @ 100 PSI, 175 Max PSI
NAC 89348NVAT

GAS DRIVE AIR COMPRESSORS

Gas Drive Air Compressors Offer Reliable Air For Your Mobile Air Needs



Was \$1420 Now **\$1199** \$121 ^{for 12 mos.}
5 HP, 8 (2X4) GALLON
1 Stage, Horz.
15.4 ACFM @ 100 PSI, 150 Max. PSI
NAC 8942508H

Was \$3670 Now **\$3300** \$105 ^{for 48 mos.}
13 HP, 30 GALLON
2 Stage, Horz.
24 ACFM @ 100 PSI, 175 Max. PSI
NAC 891333GTH

Was \$4720 Now **\$4040** \$111 ^{for 60 mos.}
16 HP, 30 GALLON
2 Stage, Horz.
35 ACFM @ 100 PSI, 175 Max. PSI
NAC 891633GT

PREMIER SIMPLEX AIR COMPRESSORS

PREMIER
AIR COMPRESSOR



Premier Are Fully Featured Models
w/These Included Features:

- Low oil level switch
- Cast iron aftercooler
- Automatic tank drain
- Anti-vibration pads
- Heavy duty cast iron slow turning pump
- Baldor electric motor
- Heavy duty sheet metal belt-guards
- Mounted and wired magnetic starters

Was \$3260 Now **\$2790** \$109 ^{for 36 mos.}
5 HP, 80 GALLON
2 Stage, Vertical, 208-230V,
18 ACFM @ 100 PSI, 175 Max PSI
NAC 89348VATP 1 Phase

Was \$4210 Now **\$3605** \$115 ^{for 48 mos.}
7.5 HP, 80 GALLON
2 Stage, Vertical, 208-230V,
27 ACFM @ 100 PSI, 175 Max PSI
NAC 89378VATP 1 Phase

Was \$3460 Now **\$2959** \$116 ^{for 36 mos.}
7.5 HP, 80 GALLON
2 Stage, Vertical, 208-230V,
23 ACFM @ 100 PSI, 175 Max PSI
NAC 89368VATPDS 1 Phase

Was \$4940 Now **\$4229** \$116 ^{for 60 mos.}
10 HP, 120 GALLON
2 Stage, 3 Phase, 208-230V,
35 ACFM @ 100 PSI, 175 Max PSI
NAC 89309VBTPDS Vertical



\$274
3-1/2-Ton Service Jack
NLE 7916420

Saddle Pad for 7916440
NLE 7916442* \$11.00



\$458 **3-1/2-Ton Low-Profile Long Reach Service Jack**
NLE 7916440



NLE 7912004 1,250 Lb. Engine Stand **\$347**
NLE 7916021 1.5-Ton Crane **\$468**
NLE 7915070 Geared, 1,000 Lb. Engine Stand **\$406**



LOOK NO FURTHER! WE HAVE THE TRANSMISSION JACK YOU NEED AT THE PRICE YOU WANT!

NLE 7911210 ^{DS}	300 LB. Clutch Jack	\$995
NLE 7917100	1/2-Ton Capacity Transmission Jack	\$580
NLE 7917136	Fuel Tank Adapter	\$321
NLE 7917140	1/2-Ton Capacity Transmission Jack	\$975
NLE 7917160	1,200 Lbs. Capacity, Hydraulic Transmission Jack	\$535
NLE 7917170	Low-Profile 1-Ton Capacity Transmission Jack	\$1260
NLE 7917180	1-1/2-Ton Capacity Transmission Jack	\$1490
NLE 7917200	Air/Hydraulic 1/2-Ton Transmission Jack	\$1230
CHT 7919006 ^{DS}	1-Ton Telescoping Transmission Jack	Was \$1670 Now \$1503



20 Ton, 30 Ton and 50 Ton Manual Shop Press

CHT SP20TNS^{DS}
20 Ton Press Was \$1480 Now \$1370
CHT SP30TNS^{DS}
30 Ton Press Was \$1890 Now \$1915
CHT SP50TNS^{DS}
50 Ton Press Was \$2640 Now \$3405

\$456
2-Ton Extra Long Low-Profile Jack
NLE 7916445



\$436
2-Ton Hybrid Floor Jack
NLE 7916450



\$480
2-Ton Lightweight Aluminum Jack
CHT 7916460



66 Lbs.

45 Lbs.



NLE 7913001 Air/Hydraulic, 22 Ton Truck Jack	Was \$740.99	Now \$660.00
NLE 7916570 Manual 5-Ton Service Jack		\$860.00
NLE 7916600 Manual 10-Ton Service Jack		\$1210.00
NLE 7916620 Manual/Air 10-Ton Service Jack		\$1490.00
NLE 7917330 35/22 Ton Truck Jack	Was \$1240.00	Now \$1200.00
NLE 7917332 20-Ton Truck Jack	Was \$390.99	Now \$345.00
CHT 7919000 ^{DS} 44-Ton Air Jack	Was \$2090.00	Now \$1800.00
CHT 7919001 ^{DS} 25/50-Ton Air Truck Jack	Was \$2170.00	Now \$1953.00
CHT 7919003 ^{DS} 20-Ton Truck Ramps	Was \$1340.00	Now \$1206.00
CHT 7919004 30-Ton Air Bottle Jack	Was \$477.99	Now \$430.00
CHT 7919005 50-Ton Air Bottle Jack	Was \$750.99	Now \$684.00



\$163
1,500 Lb.
NLE 7912002



\$58
3/4-Ton Load Leveler
NLE 7916006



\$204
2-Ton
NLE 7912006



4-Ton Ram Kit
NLE 7913575 **\$355**
10-Ton Ram Kit
NLE 7911142 **\$415**

SAVE ON JACKSTANDS AND BOTTLE JACKS



NLE 7915050 4-Ton	\$68
NLE 7915160 7-Ton	\$119
NLE 7915220 10-Ton	\$244
NLE 7915230 5-Ton, Forklift	\$140
NLE 7915250 10-Ton	Was \$477.99 Now \$394
NLE 7915280 22-Ton	Was \$295.99 Now \$268
NLE 7916455 3-Ton, Pin	\$121



NLE 7912230 12 Ton Short	\$110
NLE 7912240 20 Ton Short	\$140
NLE 7912246 ^{DS} 12 Ton Fast Rise	\$153
NLE 7912290 12 Ton	\$122
NLE 7912300 12 Ton Hydraulic	\$293
NLE 7912320 20 Ton Air/Hydraulic	\$200
NLE 7912330 20 Ton Air/Hydraulic	\$186



CL Challenger Lifts

INTRODUCING OUR NEW!

LIGHT BAR KIT

CL EAK0361V64AU^{DS}

\$342



9K 2-POST

CL CLFP904^{DS} /06^{DS} • OPEN-TOP LIFT
3-STAGE FRONT & REAR ARMS

Was \$7510 Now \$6672 \$162^{for 60 mos.}

10K 2-POST

CL VLE1004^{DS} /06^{DS} • VERSYMMETRIC®
3-STAGE FRONT / 2-STAGE REAR ARMS

Was \$5980 Now \$5214 \$126^{for 60 mos.}

10K 2-POST

CL CL10V304^{DS} /06^{DS} • VERSYMMETRIC®
3-STAGE FRONT & REAR ARMS

Was \$8380 Now \$7508 \$182^{for 60 mos.}

12K 2-POST

CL CL12A-LC04/06 • LOW-CEILING
3-STAGE FRONT & REAR ARMS

Was \$12429 Now \$11533

12K 2-POST

CL LE1204^{DS} /06^{DS} • HEAVY-DUTY
2-STAGE FRONT & REAR ARMS

Was \$10480 Now \$8300 \$201^{for 60 mos.}

15K 2-POST

CL E1504^{DS} /06^{DS} • HEAVY-DUTY
2-STAGE FRONT & REAR ARMS

\$13260 \$296^{for 60 mos.}

16K 2-POST

CL CL163S04^{DS} /06^{DS} • HEAVY-DUTY
3-STAGE FRONT & REAR ARMS

Was \$25200 Now \$25249 \$561^{for 60 mos.}

20K 2-POST

CL CL2004^{DS} /06^{DS} • HEAVY-DUTY
2-STAGE FRONT & REAR ARMS

Was \$32870 Now \$30589 \$680^{for 60 mos.}

FEATURED ITEM

12K ADJUSTABLE HEAVY-DUTY 2-POST

CL CL12A04^{DS} /06^{DS} \$253^{for 60 mos.} Was \$12459 Now \$11412

- Adjustable width during install from 11' 10" to 12' 10"
- Standard 3-Stage front and rear arms
- Wide range of lifting capabilities; Cars, Trucks & More

ASK HOW THIS LIFT CAN HELP YOU SERVICE EVs.



MODEL # CL12A

PRODUCT COLOR CODE 02 04 06

14K SCISSOR ALIGNMENT RACK

Was \$47470 Now \$42070

CL CLSX14^{DS} 14,000 LB.

Comes standard with:

- Pneumatic single-point locking rear slip plates
- LED lighting
- Surface- or Flush-mount options
- Optional extended ramps



ALIGNMENT PACKAGE

- 2 ROLLING JACKS
- 1 AIRLINE KIT
- 2 STAINLESS STEEL TURN PLATES
- 2 FOLD-DOWN WHEEL STOPS



STACK ADAPTER KIT

Was \$449.50 Now \$105

- CL WLP10315^{DS}
- (4) 3" STACKING EXTENSIONS
- (2) 6" STACKING EXTENSIONS
- (2) ORGANIZER RACKS

WITH PURCHASE OF CLFP9, VLE10R OR CL10

\$935^{for 60 mos.}

MODEL # CLSX14

MOBILE COLUMNS

MEDIUM-DUTY, HEAVY-DUTY & HEAVY-DUTY WIDE

Challenger's Mobile Column Lifts provide the flexibility and convenience to lift any rubber-tired vehicle, with multiple rear axles, up to 152,000 lbs., **without the need for pits, cables or compressed air.**

CL CLMM5000^{DS} \$877^{for 60 mos.}
Was \$50129 Now \$39443

CL CLHM1404^{DS} \$1155^{for 60 mos.}
Was \$6410 Now \$53144

CL CLHM1904^{DS} \$1289^{for 60 mos.}
Was \$65820 Now \$59330



NEW!

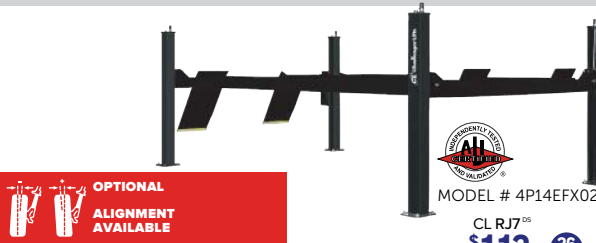

14K 4-POST

CL 4P14EFX02^{DS} & CL 4P14XFX02^{DS} | 14,000 LB.

- Features low approach angle and wide runways
- Louvered ramps provide traction even in wet conditions
- Service vehicles from 182.5" to 210.5" in wheelbase

MODEL # 4P14EFX02
CL RJ7^{DS} \$113^{for 36 mos.}

CL 4P14EFX02^{DS} (STANDARD)
Was \$10180 Now \$8864 \$215^{for 60 mos.}

CL 4P14XFX02^{DS} (EXTENDED)
Was \$10870 Now \$9544 \$232^{for 60 mos.}

BUY ONE ROLLING JACK GET THE 2ND 1/2 OFF WITH PURCHASE OF 4P14EFX OR 4P14XFX 7.5K ROLLING JACK CL RJ7^{DS} Was \$2880 Now \$2886



OPTIONAL ACCESSORIES
INTERNAL AIR LINE KIT

Was \$614^{DS} Now \$600^{DS}

CL 40230E^{DS} for 4P14EFX
CL 40230X^{DS} for 4P14XFX

10K 2-POST

CL EQ10^{DS} - 10,000 LB. LIFT

Was \$5750 Now \$4952
CL EQ10^{DS} Black \$136^{for 60 mos.}

- 3 Stage front and 2 Stage rear arms
- Drop-in pad allowing lifting from pinch weld or frame
- Premium sheathed lock release cable
- Comes with four (4) 3" adapters



MODEL # EQ10



MODEL # QMR6

12K 2-POST

CL EQ12^{DS} - 12,000 LB. LIFT

Was \$9690 Now \$8078
CL EQ12^{DS} Black \$196^{for 60 mos.}

- 2 Stage arms front and rear
- Adjustable height from 13' 10" to 14' 7"
- Drop-in pad allowing lifting from pinch weld or frame
- Includes both four (4) 3" and two (2) 6" adapters

6K PORTABLE MID-RISE

CL QMR6^{DS} 16,000 LB.

- Operates either indoors or out
- Features low drive-over clearance
- 3" & 6.875" extension adapters included

Was \$4280 Now \$3723
CL QMR6^{DS} Black \$102^{for 60 mos.}



UPGRADE YOUR EQ10

ADD TWO 6" ADAPTERS Was \$159^{DS}
STACK EXTENSIONS Now \$160
CL 10313^{DS}

"QUALITY" PRODUCTS IN STOCK AT UNBEATABLE PRICES

EXTEND THE LIFE OF YOUR LIFT GALVANIZED COATING AVAILABLE

AVAILABLE FOR AR SERIES 4115 PART CL HDGUPGRADE

Was \$4280 Now \$3759
\$103^{for 60 mos.}

15K 4-POST ALIGNMENT RACK

AR4115XAO02 & AR4115EAO02 | 15,000 LB.

\$679^{for 60 mos.}
CL AR4115EAO02^{DS} (STANDARD)
Was \$31900 Now \$30543

- Open-front design, closed-front also available
- Features NEW 26" wide runways
- Service vehicles from 183" to 210.5" in wheelbase

CL AR4115XAO02^{DS} (EXTENDED)
Was \$32810 Now \$30964

ALIGNMENT PACKAGE INCLUDES:
2 ROLLING JACKS, 1 AIRLINE KIT, 2 STAINLESS STEEL TURN PLATES, 2 FOLD-DOWN WHEEL STOPS & 2 WORK STEPS

MODEL # AR4115EAO02

quality lifts
qualitylifts.com

HOFMANN

Value Deal



HOF HOFCOMB01^{DS}

Was \$6465 Now \$6297.33 \$153^{for 60 mos.}
GEODYNA® 7100S + MONTY® 1270



GEOLINER® 678 Was \$32510 Now \$27438.67
HOFEEWA715TBV3^{DS} \$610^{for 60 mos.}

ADVANCED IMAGING TECH VIN SCANNER INCLUDED

GEOLINER® 660 Was \$27700 Now \$21994.67
HOFEEWA712TH3^{DS} \$489^{for 60 mos.}

NEXT-GEN INTERFACE

GEOLINER® 609 Was \$23899 Now \$14072.84
HOFEEWA741TH3^{DS} \$312^{for 60 mos.}

COMPACT & ECONOMICAL



FEATURED ITEM / MOBILE IMAGING WHEEL ALIGNER

GEOLINER® 770 Was \$35180 Now \$29995
HOFEEWA752BV3^{DS}

- Exclusive mobile design
- Auto-tracking camera
- Integrated OEM procedures and TSBs
- Advanced XD targets
- Touchless AC400 clamps
- VIN scanner included

Have Tools & Equipment Product Questions? Scan Here



HOFMANN



FEATURED ITEM / FULLY-AUTOMATIC 3D DIAGNOSTIC
GEODYNA® 9000P Was ~~\$27160~~ Now **\$17216**
 HOF EEWB771AP230^{DS} / PREMIUM BALANCER
 • OptiLine™ wheel set optimization
 • PowerClamp™
 • 3D no-contact camera auto data entry
 • easyALU™ auto rim detection / balancing
 • easyWEIGHT™ placement
 • Stop-in position to proper weight placement

GEODYNA® 8200P Was ~~\$21615~~ Now **\$13344**
 HOF EEWB766BEA^{DS} / TOUCH SCREEN / AUTO DATA ENTRY
 POWERCLAMP / SMARTSONAR / EASYALU **\$296** for 60 mos.
GEODYNA® 7800P Was ~~\$14810~~ Now **\$10375**
 HOF EEWB753BEB^{DS} / TOUCH SCREEN / AUTO DATA ENTRY
 POWERCLAMP / SMARTSONAR / EASYALU **\$230** for 60 mos.
GEODYNA® 7600P Was ~~\$10800~~ Now **\$8847**
 HOF EEWB765AP^{DS} / HIGH-VOLUME BALANCER
 POWERCLAMP / SMARTSONAR / EASYALU **\$215** for 60 mos.
GEODYNA® 7400L Was ~~\$9820~~ Now **\$6296**
 HOF EEWB764AL^{DS} / GENERAL REPAIR BALANCER
 QUICK NUT WHEEL CLAMP / SMARTSONAR / EASYALU **\$153** for 60 mos.

GEODYNA® 7200S Was ~~\$6990~~ Now **\$5681**
 HOF EEWB746AS^{DS} / GENERAL REPAIR BALANCER
 QUICK NUT WHEEL CLAMP / SMARTSONAR / EASYALU **\$138** for 60 mos.
HEAVY-DUTY GEODYNA® 980L
\$317 for 60 mos.
 Was ~~\$7420~~ Now **\$14264**
 HOF EEWB710DW^{DS} / FOR TRUCKS
 MAX WHEEL: 51"



FEATURED ITEM
MONTY® 8800P Was ~~\$24730~~ Now **\$22953**
 HOF EEWH778AUB^{DS} / ALL-IN-ONE TIRE CHANGER **\$510** for 60 mos.
 • powerMONT precise, fast mount/demount
 • Lower bead camera viewer
 • smartSpeed technology
 • Center-post quickLOK wheel clamping
 • On-floor bead breaker
 • Top-side bead seater
 • Dual-disc bead breaker
 • Pneumatic wheel lift
 • 220V

MONTY® 8700 Was ~~\$24620~~ Now **\$18980**
 HOF EEWH770AJA^{DS}
 MAX RIM: 30" / MAX WHEEL: 44" / 220V **\$422** for 60 mos.
MONTY® 3550EM Was ~~\$17140~~ Now **\$12028**
 HOF EEWH747B^{DS} / WITH SMARTSPEED
 MAX RIM: 26" / MAX WHEEL: 47" / 220V **\$267** for 60 mos.
MONTY® 8100S Was ~~\$12460~~ Now **\$11067**
 HOF EEWH768AC^{DS} / SWING-ARM DESIGN
 MAX RIM: 30" / MAX WHEEL: 44" / 220V **\$246** for 60 mos.
MONTY® 1675 Was ~~\$10840~~ Now **\$9339**
 HOF EEWH779CU2^{DS} / SWING-ARM DESIGN
 MAX RIM: 30" / MAX WHEEL: 44" **\$227** for 60 mos.
MONTY® 1675 Was ~~\$10860~~ Now **\$10075**
 HOF EEWH779CU1^{DS} / SMARTSPEED™
 MAX RIM: 30" / MAX WHEEL: 44" / 220V **\$224** for 60 mos.

MONTY® 1575B Was ~~\$9870~~ Now **\$5573**
 HOF MONTY1575B^{DS}
 MAX WHEEL WIDTH: 13" MAX WHEEL: 40" **\$135** for 60 mos.
MONTY® 1625B Was ~~\$8990~~ Now **\$7283**
 HOF MONTY1625B^{DS}
 MAX WHEEL WIDTH: 15" MAX WHEEL: 53" **\$177** for 60 mos.
MONTY® 1625EM Was ~~\$13300~~ Now **\$8186**
 HOF M1625EM110B^{DS} / SWING-ARM MOUNT
 MAX RIM: 24" / MAX WHEEL: 50" **\$199** for 60 mos.
MONTY® 3550EM Was ~~\$15810~~ Now **\$11349**
 HOF M3550EM110B^{DS} / TILT-TOWER MOUNT
 MAX RIM: 26" / MAX WHEEL: 47" **\$252** for 60 mos.

SCAN FOR DEMO



4-POST / SCISSOR ALIGNMENT LIFTS

12K 4-POST **\$378** for 60 mos. Was ~~\$22590~~ Now **\$16999**
 HOF EELR728APKG^{DS}
 CLOSED-FRONT / STANDARD LENGTH
15K 4-POST **\$667** for 60 mos. Was ~~\$32090~~ Now **\$29999**
 HOF EELR708APKG^{DS}
 OPEN-FRONT / EXTENDED LENGTH
12K SCISSOR **\$568** for 60 mos. Was ~~\$27020~~ Now **\$25576**
 HOF EELR709APKG^{DS} / STANDARD
12K SCISSOR **\$568** for 60 mos. Was ~~\$27040~~ Now **\$25576**
 HOF EELR724APKG^{DS} / FLUSH-MOUNT
15K 4-POST **\$722** for 60 mos. Was ~~\$44970~~ Now **\$32468**
 HOF EELR706LLPKG^{DS} / OPEN-FRONT
 STANDARD LENGTH, LIGHTS & LOCKING KIT

15K 4-POST **\$653** for 60 mos. Was ~~\$39350~~ Now **\$29381**
 HOF EELR706APKG^{DS}
 OPEN-FRONT / STANDARD LENGTH
15K 4-POST **\$813** for 60 mos. Was ~~\$60459~~ Now **\$36579**
 HOF EELR708GLLPK
 GALVANIZED RUNWAYS, EXT. LENGTH, LIGHTS AND LOCKING KIT
14K SCISSOR **\$880** for 60 mos. Was ~~\$42350~~ Now **\$39581**
 HOF EELR787APKG^{DS} / STANDARD
14K SCISSOR **\$880** for 60 mos. Was ~~\$42350~~ Now **\$39581**
 HOF EELR788APKG^{DS}
15K 4-POST **\$746** for 60 mos. Was ~~\$54549~~ Now **\$33579**
 HOF EELR708GPKG^{DS}

15K 4-POST Was ~~\$58059~~ Now **\$35468**
 HOF EELR706GLLPK^{DS} / OPEN-FRONT
 GALV. RUNWAYS, STANDARD LENGTH
 W/ LIGHTS & LOCKING KIT **\$788** for 60 mos.
15K 4-POST Was ~~\$53949~~ Now **\$32381**
 HOF EELR706GPKG^{DS} / OPEN-FRONT
 GALVANIZED RUNWAYS
 STANDARD LENGTH **\$720** for 60 mos.
14K SCISSOR Was ~~\$46000~~ Now **\$42788** **\$951** for 60 mos.
 HOF EELR790APKG^{DS} / FLUSH-MOUNT
 LIGHTS AND LOCKING KIT
14K SCISSOR Was ~~\$46000~~ Now **\$42788** **\$951** for 60 mos.
 HOF EELR789APKG^{DS} / STANDARD
 LIGHTS AND LOCKING KIT

LIFT PACKAGES INCLUDE: ROLLING JACKS, TURNPLATES & PADDLE KIT, BUILT-IN AIRLINE KIT AND REAR SLIP-PLATES

THE ONE LIFT TO SERVICE THEM ALL!



NEW SPOA10-AV ALL-VEHICLE LIFT WITH AV ARMS
 10K CAPACITY ASYMMETRIC COLUMN
 3 STAGE AV ARMS / ROUND and FRAME-ENGAGING ADAPTERS Model*
 RTY SPOA10N20MOR / \$8189



Serving the Shops since 1925
 VEHICLE LIFTING | WHEEL SERVICE
 A/C SOLUTIONS | SHOP EQUIPMENT
 ALIGNMENT | DIAGNOSTICS & CALIBRATION

SCAN HERE
 FOR MORE INFO AND THE HOTTEST DEALS
 SEE THE ENTIRE ROTARY AND FORWARD CATALOG ONLINE!



ROTARY 2-POST LIFTS
 10K CAPACITY / SYMMETRIC COLUMN
 2 STAGE ARMS / FLIP-UP ADAPTER
 MODEL* RD for Red and BL for Blue
 RTY SPO10N1500RD^{DS} / **\$7259** **\$176** for 60 mos.
 10K CAPACITY / ASYMMETRIC COLUMN
 2 STAGE ARMS / FLIP-UP ADAPTER
 MODEL* RD for Red and BL for Blue
 RTY SPOA10N1500RD^{DS} / Was ~~\$7260~~ Now **\$7259** **\$176** for 60 mos.
 12K CAPACITY / SYMMETRIC COLUMN
 2 STAGE ARMS / FRAME ADAPTER
 MODEL* RD for Red and BL for Blue
 RTY SPO12N10T5BL^{DS} / Was ~~\$11760~~ Now **\$11719** **\$260** for 60 mos.



ROTARY ALIGNMENT LIFTS
 14K CAPACITY
 4 POST DRIVE-ON
 182" WHEELBASE
 MODEL* RD for Red and BL for Blue
 RTY ARO14N10IYBL^{DS}
 Was ~~\$3570~~ Now **\$3129** **\$694** for 60 mos.
 12K CAPACITY
 SCISSOR DRIVE-ON
 183 1/2" WHEELBASE
 MODEL / RED LIFT ONLY
 RTY XA12N000RD^{DS}
\$653 for 60 mos. Was ~~\$40140~~ Now **\$29379**

MOBILE COLUMN LIFTS
 FLEX MAX™ REMOTE-CONTROLLED LIFTS
 14K CAP. COLUMN
 4 COLUMN SET
 MODEL / BLACK LIFT ONLY
 RTY MCHM414^{DS} **\$1087** for 60 mos.
 Was ~~\$51980~~ Now **\$48899**

ROTARY TIRE CHANGERS

R146RPS Swingarm Pro
 RTY RWC24626IRP^{DS}
 Was ~~\$9210~~ Now **\$8569** **\$208** for 60 mos.



\$506 for 60 mos.
 R1200 Leverless Pro
 RTY RWC1200^{DS}
 Was ~~\$2420~~ Now **\$22789**



ROTARY WHEEL BALANCER

R155 PRO 3D
 RTY RWB355SB^{DS}
 Was ~~\$8700~~ Now **\$8019** **\$194** for 60 mos.



\$358 for 60 mos.
 RTY RW146155C^{DS}
 Was ~~\$17970~~ Now **\$16139**



ROTARY COMBO SET

R146RPS Tire Changer with
 R155 PRO 3D Wheel Balancer



ROTARY carries an industry-leading 3 year warranty. FREE shipping, set up, and on-site training on all Rotary wheel service equipment!

FORWARD LIFT BY ROTARY CAR AND TRUCK 2-POST LIFTS

10K CAPACITY LIFTS SYMMETRIC COLUMN
 F10 MODEL* RD for Red and BL for Blue
 FWD F10N500MBL^{DS} / Was ~~\$5700~~ Now **\$5039** **\$122** for 60 mos.
 AVAILABLE IN BLUE ONLY
 15K CAPACITY LIFTS / SYMMETRIC COLUMN
 DP15 MODELS* RD for Red and BL for Blue
 12' 10-3/4" LIFT HEIGHT
 FWD DP15N000BL^{DS} Was ~~\$18090~~ Now **\$14219** **\$316** for 60 mos.
 16' 7" LIFT HEIGHT
 FWD DP15N002^{DS} Was ~~\$17280~~ Now **\$15289** **\$340** for 60 mos.
 18K CAPACITY LIFTS / SYMMETRIC COLUMN
 DP18 PRO MODELS* RD for Red and BL for Blue
 12' 10-3/4" LIFT HEIGHT
 FWD DP18N000BL^{DS} Was ~~\$22690~~ Now **\$21539** **\$479** for 60 mos.
 16' 7" LIFT HEIGHT
 FWD DP18N002^{DS} Was ~~\$22620~~ Now **\$22419** **\$498** for 60 mos.
 14' 8" LIFT HEIGHT
 FWD DP18N001BL^{DS} Was ~~\$22690~~ Now **\$21539** **\$479** for 60 mos.

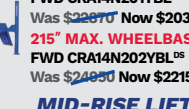
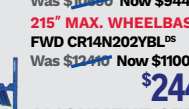
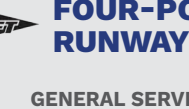

FOUR-POST RUNWAY LIFTS

GENERAL SERVICE
 14K CAPACITY RUNWAY LIFTS
 182 1/2" MAX. WHEELBASE
 MODELS* RD FOR RED AND BL FOR BLUE
 FWD CR14N201YBL^{DS} Was ~~\$10650~~ Now **\$9449** **\$229** for 60 mos.
 215" MAX. WHEELBASE
 FWD CR14N202YBL^{DS}
 Was ~~\$12410~~ Now **\$11009** **\$244** for 60 mos.
 ALIGNMENT SERVICE
 14K CAPACITY RUNWAY LIFTS
 182 1/2" MAX. WHEELBASE
 MODELS* RD FOR RED AND BL FOR BLUE
 FWD CRA14N201YBL^{DS} Was ~~\$32870~~ Now **\$20319** **\$451** for 60 mos.
 215" MAX. WHEELBASE
 FWD CRA14N202YBL^{DS}
 Was ~~\$24950~~ Now **\$22159** **\$492** for 60 mos.
 MID-RISE LIFT
 6K CAPACITY
 MODEL / BLACK ONLY
 FWD 6000MRLFBK^{DS} Was ~~\$4120~~ Now **\$3789** **\$104** for 60 mos.

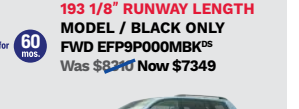
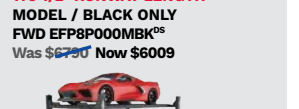

COATS

TOTAL SHOP SOLUTIONS - WHEEL SERVICE, ALIGNMENT, AND LIFTS

All Coats products, excluding lifts, come with free setup and training. To view full product lineup, visit CoatsCompany.com



MAXX SERIES TIRE CHANGERS

MOST POPULAR MODEL



CTC MAXX70220
\$206 for 60 mos

CTC MAXX90A
\$300 for 60 mos

CTC MAXX90220
\$231 for 60 mos

CTC MAXX80220
\$231 for 60 mos

CTC MAXX50A
\$158 for 60 mos

CTC MAXX802SPD
\$244 for 60 mos

Model	Maxx 90	Maxx 90 2-Speed	Maxx 80	Maxx 80 2-Speed	Maxx 70	Maxx 50
220v	N/A	CTC MAXX90220 ^{DS}	CTC MAXX80220 ^{DS}	CTC MAXX802SPD ^{DS}	CTC MAXX70220 ^{DS}	N/A
110v	N/A	N/A	CTC MAXX80A ^{DS}	N/A	CTC MAXX70A ^{DS}	CTC MAXX50 ^{DS}
Air	CTC MAXX90A ^{DS}	N/A	CTC MAXX80A ^{DS}	N/A	CTC MAXX70A ^{DS}	CTC MAXX50A ^{DS}
	Was \$2200 Now \$13499	Was \$2200 Now \$13499	Was \$18210 Now \$10399	Was \$18770 Now \$10999	Was \$14450 Now \$8499	Was \$8350 Now \$6499

Maxx 90

- + Clamp up to 30" wheel out of the box
- + Leverless Duckhead bead lifter

Maxx 80

- + RoboRoller powered assist device
- + New bead breaker for larger assemblies
- + Hand / Foot controlled bead loosener
- + Dual Nozzle Bead Sealer
- + Grip Max 2.0 clamps

Maxx 70

- + Patented Robo-Arm helper device

All Models

- Built for the harsh work environments
- Work on up to 16" tire width
- Duckhead Mount/Dismount Tool Head
- New bead breaker for larger assemblies
- Dual Nozzle Bead Sealer
- Modular & Upgradeable

DIRECT DRIVE WHEEL BALANCERS



CTC 16003DA
\$233 for 60 mos

CTC 15003DA
\$218 for 60 mos

CTC 13002DA
\$140 for 60 mos

Model	1600	1500	1300
220V, 1P	CTC 16003DA ^{DS} Was \$16190 Now \$10499	CTC 15003DA ^{DS} Was \$12410 Now \$8999	CTC 13002DA ^{DS} Was \$8350 Now \$5799
220V, 3P	CTC 16003DB ^{DS} Was \$16190 Now \$10499	CTC 15003DB ^{DS} Was \$12410 Now \$8999	CTC 13002DB ^{DS} Was \$8350 Now \$5799

1600

- + Enhanced Laser Guided Operation[®]
- + Stop, Lock & Index
- + ProBalance Technology[®]
- + Touchscreen
- + Speed Thread[™]
- + LED barrel lighting
- + Language software - English, Spanish, French, Chinese
- + Hood damper

1500

- + Laser-Guided Operation
- 5 O'Clock Tape Application
- 12 O'Clock Clip Application
- + Automatic 3-D Data Entry
- + Stop and Lock Inverter Technology
- + Double-Sided Collets Included

1300

- Powered by Direct Drive - No More Need for Daily Calibration
- Static-On-Screen[®] Display Identifies Any Excess Residual Static Imbalance
- Automatic 2-D Data Entry on Wheel Diameter and Offset Measurement

CENTER POST TIRE CHANGERS



90C

- + Leverless Duckhead bead lifter

80C

- Brand-New Center Clamp Design for Ease of Use and Minimized Metal-to-Metal Contact
- Available in Rugged 220V, 2HP Electric Motor, or Air Motor
- RoboRoller Device for Direct Pressure on Tough Assemblies
- Clamping Range from 10" - 30"
- Standard Auxiliary Bead Sealer System

Model	90C	80C
220V	CTC90CEH220	CTC80CEH220
Air	CTC90CAH3	CTC80CAH3
	\$14,999	\$11,999

RC-SERIES TIRE CHANGERS



RC-55

- + RC Robo-Arm[®] Helper Device

RC-45

- Foot-Controlled Bead Loosener
- Maximum Tire Width: 10.5"
- Clamping Range from 6" - 24"
- Steel Clamps Standard
- Durable Steel Duckhead Standard
- Small Footprint

Model	RC-55	RC-45
Elec. 110v	CTC RC55E ^{DS}	CTC RC45E ^{DS}
Air	CTC RC55A ^{DS}	CTC RC45A ^{DS}
	Was \$9950 Now \$7499	Was \$7380 Now \$5499

SPACE SAVING BALANCERS



1185

- Color LCD Video Display
- Laser Weight Placement Guidance
- Live Position Indexing Guidance
- 110V Power - Plug In Anywhere
- Space Saving Design
- Auto Start Hood

885

- 110V Power - Plug in Anywhere
- Space-Saving Design
- Auto Start Hood
- Direct Tape-A-Weight Placement

Model	1185	885
110v, 1P	CTC 1185 ^{DS}	CTC 885 ^{DS}
	Was \$7520 Now \$5299	Was \$6240 Now \$4299

6500 3D ALIGNER

ALIGN VEHICLES QUICKLY & EASILY- We designed our interface to be straight forward and tech friendly whether your an industry veteran or brand new.

FLEXIBILITY FOR YOUR SHOP'S NEEDS-

No matter what vehicle in your shop you're trying to roll, we have a roll option to make it quick and easy.

POWERFUL SOFTWARE FEATURES-

We packed our 6500 with features and powerful software like our Toe Plus tool and All Measurement Screen.

TIRE GRIPPING WHEEL CLAMPS-

Our dynamic clamps can extend to up to 43". They easily install with no metal to metal contact.



Was \$32530
Now \$24999
CTC 6500
\$555 for 60 mos

12K / 14K / 16K ALIGNMENT SCISSOR LIFTS

- High Quality; 100% North American made
- Two heavy duty rolling jacks
- Stainless Steel turn plates & roll back bar
- Superior structural strength provides longer life and more precise alignments

- Scissor Rack and Pinion Style Gear Rack
- Open Runway Slots Under Rear Slip Plates
- Deck Length: 185" / 4700mm
- Deck Width: 23" / 584 mm



Was \$45830
Now \$39999
Was \$49210
Now \$41999
Was \$54920
Now \$43999

\$889 for 60 mos
8KSC12KITP^{DS} - 12k
\$934 for 60 mos
8KSC14KITP^{DS} - 14k
\$978 for 60 mos
8KSC16KITP^{DS} - 16k



LEARN MORE & SHOP OUR PRODUCTS ONLINE



10K / 12K / 16K / 20K 2-POST LIFTS



Was \$11270
Now \$6999
CTC 4TV21NSR1^{DS} - 10k Red
CTC 4TV21NSB1^{DS} - 10k Blue
Was \$16220
Now \$10999
CTC 4T212SSR1^{DS} - 12k Red
CTC 4T212SSB1^{DS} - 12k Blue
Was \$32780
Now \$20999
CTC 4T216SSR1^{DS} - 16k Red
CTC 4T216SSB1^{DS} - 16k Blue
Was \$42810
Now \$27999
CTC 4T220SSR1^{DS} - 20k Red
CTC 4T220SSB1^{DS} - 20k Blue



15K & 19K ALIGNMENT 4-POST LIFTS

Lift Packages Feature:

- Two premium rolling jacks with 5yr part warranty
- Stainless Steel turn plates & roll back bar
- 9" / 229mm steel pulleys with 1/2" / 12.3mm cables
- Wide 23" / 584 mm double wall non flex runways
- Heavy Duty 3" x 8 1/4" / 74 - 210mm
- Water trap/ air regulator/ filter
- Single point air lock releases
- Open Runways with 7/8"/875mm plated slip plate balls
- Premium US made Bucher Power Unit



Was \$43700
Now \$34999
CTC 8K4P15SKITP^{DS}
\$778 for 60 mos
Was \$45540
Now \$36699
CTC 8K4P15XKITP^{DS}
\$816 for 60 mos
Was \$63330
Now \$36999
CTC 8K4T419CSAR1^{DS}
\$822 for 60 mos
Was \$66440
Now \$38999
CTC 8K4T419CXAR1^{DS}
\$867 for 60 mos

CHD6330 HD TIRE CHANGER



CTC CHD6330
\$444 for 60 mos

Was \$27700
Now \$19999
CTC CHD6330^{DS}
Three Phase Electric
Was \$27020
Now \$19999
CTC CHD63301PH^{DS}
Single Phase Electric

6450 HD BALANCER & LIFT



Was \$27190
Now \$17999
\$400 for 60 mos

CTC 64503DLEA^{DS} - Single Phase Electric
CTC 64503DLEB^{DS} - Three Phase Electric

- Powerful 1.5 HP direct drive motor
- Static on screen provides simultaneous display of static & dynamic data & identifies any excess residual static imbalance.
- DCS ensures the 6450 is the most accurate heavy duty balancer on the market
- Laser weight placement for 3 parameter auto data entry in tape modes
- 500 lbs. Met Lab / UL approved.
- Designed for front line, high-volume balancing.
- Easy-to-read LED readouts.
- Auto Data Entry for all three parameters with one touch. Just drop the hood and go.
- Auto indexing automatically moves the wheel to the required weight positions.
- Stop and Lock spindle for easy, accurate weight placement
- Wheel lift included

Have Tools & Equipment Product Questions? Scan Here





Better together

No matter the size of your shop, we have your ultimate comfort combo to keep your comfort level high and your heating bills low.



Big Commercial Fans (HVLS fans)								
MODEL	DIAMETER	BLADES	CFM	INDUSTRY SPACING	PART NO.	WAS PRICE	PRICE	AS LOW AS
XP	14 ft.	4	121,923	56 ft.	EL 81011538 DS	Was \$4999	Now \$4739	\$130 for 60 mos.
ECO	16ft.	4	154,024	64 ft	EL 810115261P DS	Was \$5509	Now \$5529	\$134 for 60 mos.
TITAN	24ft.	5	316,000	120 ft.	EL 810115211P DS	Was \$7229	Now \$7199	\$175 for 60 mos.

BIG FANS

Increase employee productivity and reduce energy costs year round and circulating warmth when it's cold.

- Cools in Summer
- Warms in Winter
- Do-It-Yourself Installation



More air... less noise

High performance fans designed to move impressive amounts of air, equalizing temperature and humidity at a fraction of the cost and in spaces where HVLS fans are not applicable.



AirMobile

EL 81011300 DS

- * Whisper-quiet operation
- * Flexible, portable
- * 59 inch diameter
- * 43,000 CFM

Was ~~\$3459~~ **\$105** for 48 mos.
Now **\$3299**



AirFocus

EL 81011304 DS

- * Available for wall or ceiling mount
- * 59 inch diameter
- * 43,000 CFM

Was ~~\$2989~~ **\$109** for 36 mos.
Now **\$2799**

MAHLE

Was ~~\$48320~~
Now **\$47128** **\$1048** for 60 mos.

Mahle 485 80095 00

CML-7X4 28 Ton Commercial Vehicle Mobile Column Lift Set of 4

RTI 4858009500 DS

RTI 4858009900 DS CML-9X4 38 Ton Was \$59650 Now **\$58149** **\$1264** for 60 mos.



\$4660 **\$133** for 60 mos.

Mahle Trans JackCTJ-2200TC w/ TCHS kit

RTI 4858003200 DS



Ranger

Driving Excellence in Wheel Service Equipment

Wheel Balancer & Tire Changer

110V COMBO #BPK 5140423 DS

DST30P R76ATR-L

- 40 mm Shaft
- Tilt-Back
- Six-Second Balancing Times
- Power Assist
- All PACKAGE DEALS INCLUDE ONE Wheel Weight Combo 700 black & 700 silver stick-on wheel weights



\$196 for 60 mos.
\$8100

FREE SHIPPING



VOLTAGE
110V / 220V

Max. Wheel Diameter - 8" - 30"
Max. Tire Weight - 150 lbs.
Max. Tire Diameter - 50"

VOLTAGE
a

Maximum Tire Diameter - 43"
Internal Clamping - 10" - 30"
External Clamping - 8" - 26"

Wheel Balancer & Tire Changer

110V COMBO #BPK 5140426 DS

DST-2420 R980AT-L

- 40 mm Shaft
- Swing-Arm
- Self-Calibration - Power Assist Function
- All PACKAGE DEALS INCLUDE ONE Wheel Weight Combo 700 black & 700 silver stick-on wheel weights



\$185 for 60 mos.
\$7610

FREE SHIPPING

VOLTAGE
110V / 220V

Max. Wheel Diameter - 10" - 30"
Max. Tire Weight - 145 lbs.
Max. Tire Diameter - 47"

VOLTAGE
110V

Maximum Tire Diameter - 50"
Internal Clamping - 10" - 30"
External Clamping - 8" - 26"

Truck Wheel Balancer

RB24T #BPK 5140149 DS

- Complete With Deluxe Adapter Kit and Quick-Chuck

FREE SHIPPING



\$216 for 60 mos.

VOLTAGE
220V

Max. Wheel Diameter - 30"
Max. Tire Weight - 400 lbs.
Max. Tire Diameter - 50"

Super-Duty Truck Tire Changer

R26FLT #BPK 5140137 DS



\$228 for 60 mos.

VOLTAGE
220V

Maximum Rim Diameter - 14" - 26"
Drive System - Electric / Hydraulic
Maximum Tire Diameter - 63"

BendPak

AMERICA'S FAVORITE SINCE 1965

\$9520 **\$231** for 60 mos.

12K 2-Post Clearfloor Lift

XPR-12CL #BPK 5175405 DS

FREE SHIPPING



\$302 for 60 mos.

\$13610

15K Heavy-Duty 2-Post Clearfloor Lift

XPR-15CL #BPK 5175408 DS

- Drive Thru Clearance - 104.75"
- Width - 155" / Height - 170"
- Max. Rise - 69"
- Triple-telescoping arms provide increased range
- Extended height top-beam provides greater overhead clearance
- Dual direct-drive hydraulic cylinders

14K 4-Post Alignment Lift

HDS-14LSX #BPK 5175171 DS

Extended Length



FREE SHIPPING

\$11130
\$247 for 60 mos.

- Max. 2 Wheel Align. - 182" / Max. Rise - 70"
- Width - 130" / Length - 241"
- Runway Length - 199"

18K Heavy-Duty 4-Post Service Lift

HDS-18E #BPK 5175968 DS

Standard Length



\$20910
\$465 for 60 mos.

- Width - 153.5" / Length - 312.75"
- Runway Length - 257.5"
- Max. Rise - 61.25"





METALWORKING & LIFTING SYSTEMS

DRILL PRESSES



\$899	\$999	\$1729
15" Bench	15"	20"
JET 354401 ^{DS}	JET 354400 ^{DS}	JET 354402 ^{DS}

- All models have cast iron head
- Chuck and key included



BANDSAWS



\$1949
7" x 12"
Horizontal/
Vertical Bandsaw
JET 414559^{DS}



\$2059
7" x 12" Deluxe
Horizontal/
Vertical Bandsaw
JET 414560^{DS}



JLP-A SERIES



\$155⁰⁴	\$237⁶⁶
1/4 Ton, 5' Lift Mini-Puller JET 287100	1/2 Ton, 10' Lift Mini-Puller JET 287201
\$304⁹⁸	\$368²²
3/4 Ton, 10' Lift JET 287301	1-1/2 Ton, 10' Lift JET 287401

- Innovative brake wear indicator.
- Easy free chain design.
- Complies with ANSI / ASME B30.21 and HST-3 Standards.

S90 SERIES

\$213¹⁸
1 Ton, 10' Lift
JET 101910

- Grade 80 black oxide coated load chain.
- Weston style double ratchet pawl brake design.
- Complies with ANSI / ASME B30.16 and HST-2 Standards.



FLEXZILLA®

STATIONARY AIR COMPRESSORS



10HP
120 GAL

Part No.	HP Spec	Tank Size	Pump Style	Price
FXZ FS05V080Y1 ^{DS}	5 HP	80 GAL.	Splash	\$3999
FXZ FS07V080Y1 ^{DS}	7.5 HP	80 GAL.	Splash	\$4399
FXZ FS10V080V1 ^{DS}	10 HP	80 GAL.	Splash	\$4999
FXZ FS10V120V1 ^{DS}	10 HP	120 GAL.	Splash	\$5699
FXZ FS05V080I1 ^{DS}	5 HP	80 GAL.	Pressure	\$4599
FXZ FXS07V080V1 ^{DS}	7.5 HP	80 GAL.	Pressure	\$5399
FXZ F07V080V3208 ^{DS}	7.5 HP	80 GAL.	Pressure	\$5699
FXZ F07V080V3230 ^{DS}	7.5 HP	80 GAL.	Pressure	\$5499
FXZ FXS10V080V1 ^{DS}	10 HP	80 GAL.	Pressure	\$5699
FXZ F10V080V3208 ^{DS}	10 HP	80 GAL.	Pressure	\$5999
FXZ F10V080V3230 ^{DS}	10 HP	80 GAL.	Pressure	\$5999
FXZ FXS10V120V1 ^{DS}	10 HP	120 GAL.	Pressure	\$6499
FXZ F10V120V3208 ^{DS}	10 HP	120 GAL.	Pressure	\$6699
FXZ F10V120V3230 ^{DS}	10 HP	120 GAL.	Pressure	\$6699
FXZ FXS10A120V1 ^{DS}	20 HP	240 GAL.	Pressure	\$12499

AIR HOSES, REELS & ACCESSORIES



HFZ3850YW2



AG1500FZKIT



AL2025FZ-2



FZ8120603



L8611FZ



L8305FZ

Part No.	HP Spec	Price
FXZ HFZ1225YW3 ^{DS}	Flexzilla® Air Hose, 1/2" x 25', 3/8" MNPT Fittings	\$39.99
FXZ HFZ1250YW3 ^{DS}	Flexzilla® Air Hose, 1/2" x 50', 3/8" MNPT Fittings	\$54.99
FXZ HFZ3825YW2 ^{DS}	Flexzilla® Air Hose, 3/8" x 25', 1/4" MNPT Fittings	\$24.99
FXZ HFZ3850YW2 ^{DS}	Flexzilla® Air Hose, 3/8" x 50', 1/4" MNPT Fittings	\$39.99
FXZ AL2000FZ ^{DS}	Flexzilla® Chuck Inflator with 12' Hose	\$29.99
FXZ AL2025FZ ^{DS}	Flexzilla® Combo Inflator Kit with Flexzilla Air Hose 3' and 15' Extensions	\$119.99
FXZ HGH2FZ ^{DS}	Flexzilla® Truck Tire Inflator Kit with 3/8" x 50' Hose	\$59.99
FXZ AG1500FZKIT ^{DS}	Flexzilla® X1™ Blow Gun Kit, 10-Piece	\$39.99
FXZ L8305FZ ^{DS}	Flexzilla® Pro Retractable Air Hose Reel with Levelwind™ Technology, 3/8" x 50'	\$279.99
FXZ L8306FZ ^{DS}	Flexzilla® Pro Retractable Air Hose Reel with Levelwind™ Technology, 3/8" x 75'	\$309.99
FXZ L8335FZ ^{DS}	Flexzilla® Pro Retractable Air Hose Reel with Levelwind™ Technology, 1/2" x 50'	\$319.99
FXZ L8550FZ ^{DS}	Flexzilla® Manual Air Hose Reel, Open Face, 3/8" x 50'	\$129.99
FXZ L8650FZ ^{DS}	Flexzilla® Manual Air Hose Reel, Open Face, Fixed, Heavy-Duty, 3/8" x 50'	\$154.99
FXZ L8651FZ ^{DS}	Flexzilla® Manual Air Hose Reel, Open Face, Portable, 3/8" x 50'	\$154.99
FXZ L8250FZ ^{DS}	Flexzilla® Enclosed Plastic Retractable Air Hose Reel, 3/8" x 50'	\$154.99
FXZ L8611FZ ^{DS}	Flexzilla® Retractable Air Hose Reel, Open Face, Single Axle Arm, 3/8" x 50'	\$259.99

If it's not ZillaGreen®, it's not Flexzilla®

FLEXZILLA, The Flexzilla Stylized X and the color CHARTREUSE are all registered trademarks of Weems Industries, Inc. Silencer™ Patent Pending © 2024 Legacy Manufacturing Company. All Rights Reserved.

REFRIGERATED AIR DRYERS

Part No.	Volt	CFM	HP Spec	Price
FXZ FDRCF1150030 ^{DS}	115	30	5-7.5	\$2099
FXZ FDRCF1150058 ^{DS}	115	58	10	\$2999
FXZ FDRCF1150115 ^{DS}	115	115	15-25	\$3709



COMPRESSORS
IN ACTION



WATER



HFZG550YW

Part No.	HP Spec	Price
FXZ HFZG550YW ^{DS}	Flexzilla® Garden Hose, 5/8" x 50', 3/4" - 11 1/2 GHT Fittings	\$49.99
FXZ HFZG5100YW ^{DS}	Flexzilla® Garden Hose, 5/8" x 100', 3/4" - 11 1/2 GHT Fittings	\$99.99

Have Tools & Equipment Product Questions? Scan Here





BE POWER EQUIPMENT

BEPOWEREQUIPMENT.COM

GENERATORS & INVERTERS

GENERATOR ● INVERTER ■

 \$809 BEP BE2800I DS · 2,800 PEAK WATTS · 3,300 RUNNING WATTS · GAS FUEL	 \$1229 BEP BE4700ID DS · 4,700 PEAK WATTS · 3,600 RUNNING WATTS · GAS & PROPANE FUEL \$124 for 12 mos	 \$1729 BEP BE7500ID DS · 7,500 PEAK WATTS · 6,000 RUNNING WATTS · GAS & PROPANE FUEL \$174 for 12 mos	 \$3059 BEP BE10500IT DS · 10,500 PEAK WATTS · 8,500 RUNNING WATTS · GAS, PROPANE & NATURAL GAS FUEL \$120 for 36 mos	 \$615 BEP BE3800 DS · 3,800 PEAK WATTS · 3,000 RUNNING WATTS · GAS FUEL	 \$695 BEP BE4800 DS · 4,800 PEAK WATTS · 3,800 RUNNING WATTS · GAS FUEL	 \$939 BEP BE7000 DS · 7,000 PEAK WATTS · 5,500 RUNNING WATTS · GAS FUEL	 \$1309 BEP BE11000 DS · 11,000 PEAK WATTS · 7,500 RUNNING WATTS · GAS FUEL \$132 for 12 mos	 \$1685 BEP BE12500T DS · 12,500 PEAK WATTS · 9,000 RUNNING WATTS · GAS, PROPANE & NATURAL GAS FUEL \$170 for 12 mos
--	--	--	---	---	---	---	--	--

PRESSURE WASHERS

COLD WATER 💧 HOT WATER 🔥

 Was \$804 Now \$690 BEP BE3365HA DS · HONDA GX200 · 3,300 PSI 2.3 GPM · MAINTENANCE FREE AXIAL PUMP	 Was \$664 Now \$550 BEP BE3365KA DS · KOHLER SH270 · 3,300 PSI 2.3 GPM · MAINTENANCE FREE AXIAL PUMP	 Was \$1280 Now \$1215 BEP B389HA DS · HONDA GX270 · 3,800 PSI 3.5 GPM · TRIPLEX PUMP \$122 for 12 mos	 Was \$9259 Now \$9169 BEP HW3524HA12V DS · HONDA GX690 · 3,500 PSI 8.5 GPM · BELT DRIVE SYSTEM \$222 for 60 mos	 Was \$8599 Now \$8510 BEP HW4024HA12V DS · HONDA GX690 · 4,000 PSI 5.5 GPM · BELT DRIVE SYSTEM \$206 for 60 mos	 Was \$6289 Now \$5975 BEP HW4013HBG DS · HONDA GX390 · 4,000 PSI 4.0 GPM · BELT DRIVE SYSTEM \$145 for 60 mos	 Was \$5900 Now \$5780 BEP HW4013HG DS · HONDA GX390 · 4,000 PSI 4.0 GPM · TRIPLEX PUMP \$140 for 60 mos	 \$4499 BEP HW2765HG DS · HONDA GX200 · 2,700 PSI 2.8 GPM · DIRECT DRIVE \$124 for 60 mos
--	---	---	---	---	---	---	---

AIR COMPRESSOR

MODEL #	DESCRIPTION	WAS PRICE	PRICE
BEP AC658HB DS	AC 6.5HP HONDA	Was \$1420	Now \$1349

WATER PUMPS

MODEL #	DESCRIPTION	WAS PRICE	PRICE
BEP WS1565H DS	1.5" FIRE SUPPRESSION	Was \$994	Now \$850
BEP WP2065HL DS	2" WP HONDA	Was \$675	Now \$645
BEP WP2070S DS	2" WP POWEREASE	Was \$350	Now \$335
BEP WPK2065CM DS	2" WP KIT	Was \$634	Now \$605
BEP WP3065HL DS	3" WP HONDA	Was \$709	Now \$675
BEP WP3070S DS	3" WP POWEREASE	Was \$420	Now \$400
BEP TP2065HT DS	2" SEMI TRASH PUMP	Was \$775	Now \$740

PRESSURE WASHER ACCESSORIES

MODEL #	DESCRIPTION	WAS PRICE	PRICE
BEP 85403014 DS	14" FLAT SURFACE CLEANER	Was \$175	Now \$159
BEP 85238156	HOSE 50FT 4,000 PSI GREY	Was \$102	Now \$100
BEP 85238151	HOSE 50FT 4,000 PSI BLACK	Was \$84	Now \$80
BEP 85225228	HOSE 25FT 4,000 PSI	Was \$68	Now \$60
BEP 85205026	36" GUN AND WAND	Was \$65	Now \$60
BEP 85400205	GARDEN HOSE QC KIT		\$10
BEP 85300102BEP	QC COUPLER 1/4" FNPT		\$6

Was \$2560 **Now \$2509**
BEP 1520FW1GENH DS
 · BALDOR
 · 1,500 PSI | 2.0 GPM
 · TRIPLEX PUMP
HOT
COLD

Was \$1780 **Now \$1745**
BEP 1520FW1ARH DS
 · BALDOR
 · 1,500 PSI | 2.0 GPM
 · TRIPLEX PUMP
COLD

FIRMAN®

POWER EQUIPMENT

POWER FOR YOU

FMR H07552 DS
 CERTIFICATION // EPA, CARB, NOM
DUAL FUEL PORTABLE GENERATOR
 9400W/7500W (GAS) / 8450W/6750 (LPG)
 ELECTRIC START

DUAL FUEL **12-HR** UP TO 12 HOURS RUNTIME
ELECTRIC START

Was \$1359
Now \$1292

FMR P03613 DS
 CERTIFICATION // EPA, CARB, NOM, cETL
GASOLINE PORTABLE GENERATOR
 4550W/3650W RECOIL START

CO ALERT **14-HR** UP TO 14 HOURS RUNTIME
4550 STARTING WATTS

Was \$539
Now \$485¹⁰

FMR W01784 DS
 CERTIFICATION // EPA, CARB, NOM, cETL
GASOLINE PORTABLE INVERTER
 2100W/1700W RECOIL START

LIGHT-WEIGHT **9-HR** UP TO 9 HOURS RUNTIME
2100 STARTING WATTS

Was \$739⁹⁹
Now \$665⁹⁹

Parts Washers & Accessories

SW FL4	OzzyMat® Multi-Layer Fluid Activation Mat	Was \$34.99	Now \$22.49
SW 1751154 DS	BenchtopPRO MicroPRO Pack	Was \$41.99	Now \$27.49
SW 1750987 DS	BenchtopPRO BT5 Ready To Use Degreasing Solution	Was \$73.99	Now \$47.49
SW SW8	OzzyJuice® Aircraft & Weapons Degreasing Solution 5 gals.	Was \$124.99	Now \$104.49
SW SW7	OzzyJuice® Parts/Brake Cleaning Solution 5 gals.	Was \$122.99	Now \$104.49
SW SW4	OzzyJuice® SW-4 Heavy Duty Degreasing Solution 5 gals.	Was \$122.99	Now \$104.49
SW SW3	OzzyJuice® Truck Grade Degreasing Solution 5 gals.	Was \$122.99	Now \$104.49
SW 1000872 DS	BenchtopPRO Bioremediating Parts Washer Kit	Was \$644.99	Now \$469.99
SW SW323 DS	Mobile Parts Washer With SW3 Truck Grade Degreasing Solution	Was \$321.00	Now \$224.99
SW SW423 DS	Mobile Parts Washer With SW4 Heavy Duty Degreasing Solution	Was \$336.00	Now \$224.99
SW SW723 DS	Mobile Parts Washer With SW7 Parts/Brake Cleaning Solution	Was \$349.00	Now \$224.99
SW SW823 DS	Mobile Parts Washer With SW8 Air Craft & Weapons degreasing Solution	Was \$336.00	Now \$224.99
SW SW425 DS	Signature Parts Washer With SW4 Heavy Duty Degreasing Solution	Was \$312.00	Now \$224.99
SW SW825 DS	Signature Parts Washer With SW8 Air Craft & Weapons degreasing Solution	Was \$310.00	Now \$224.99
SW SW725 DS	Signature Parts Washer With SW7 Parts/Brake Cleaning Solution	Was \$310.00	Now \$224.99
SW SW325 DS	Signature Parts Washer With Truck Grade Degreasing Solution	Was \$317.00	Now \$224.99

BK 7763891 DS	Tire Taxi® Tire Caddy	Was \$124	Now \$112
BK 8231050	Oil Drain Station Pedestal	Was \$164	Now \$148
BK 7763894 DS	Tire Taxi®	Was \$179	Now \$161
BK 7763892 DS	Tire Taxi® Tire Caddy Extender	Was \$214	Now \$170
BK 7763893 DS	Tire Taxi® Tire Caddy 6 Pack	Was \$469	Now \$440
BK 7154685 DS	Oil Drain Station Low Profile 25 Gal.	Was \$884	Now \$778
BK 8114013 DS	Oil Drain Station Low Profile	Was \$884	Now \$778

*DS = Special Order Item. Contact NAPA representative for lead time





TO CLAIM YOUR GREENBACK REBATE
GO TO WWW.FORNEYIND.COM/PRODUCT-REBATES
OR SCAN THE QR CODE TO THE RIGHT.



Receive a rebate when you purchase a qualifying Forney® welder from NAPA during April 1, 2024 through June 30, 2024.

**FNY 261 FORNEY® EASY WELD
140 FC-i FLUX-CORE WIRE
WELDER, 120V**

Was ~~\$401.99~~
Now \$299.00

- 140 Amp Output
- Weld Up to 1/4 in Plate
- Use with FNY 42300 Wire



**NEW
LOW
PRICE**

**FNY 251 FORNEY® EASY WELD
20 P PLASMA CUTTER, 120V**

Was ~~\$649.99~~
Now \$499.00

- Clean Cut 1/4 in
- Lightweight and Portable
- Generator Compatible



**NEW
LOW
PRICE**

**FNY 1710^{DS} MEDIUM/HEAVY
DUTY VICTOR COMPATIBLE
TORCH KIT**

Was ~~\$398.99~~
Now \$359.00



**HOT
BUYS**

GET IT DONE WITH GREEN®

**FNY 327^{DS} FORNEY® 242
DUAL MIG WELDER**

Was ~~\$2480~~
Now \$2399



- Weld from 24 ga. to 3/8 in Plate
- Weld Aluminum & Steel: Dual Set Up
- Use with FNY 85620 or 85650 Spool Gun
- 15 ft Power Cord and Torch

**FNY 323 FORNEY® 190 MULTI-
PROCESS WELDER**

Was ~~\$1410~~
Now \$1239



- Powerful 4 in 1 Welder
- MIG/Stick/Flux-Core/DC TIG
- Dual Voltage: 120V/240V
- True Set Synergic Welding

**FNY 309 FORNEY® 140
MIG WELDER**

Was ~~\$809.99~~
Now \$679



- MIG (GMAW) and Flux-Cored (FCAW)
- Weld Up to 1/4 in Thick
- Larger Cabinet for Easy Access to Spools
- Upgraded Cast Aluminum Wire Drive System

**FNY 440 FORNEY® 40 P
PLASMA CUTTER**

Was ~~\$1730~~
Now \$1579



- Clean Cut 1/2 in; Sever Cut 3/4 in
- 20 ft IPT-40 Torch
- 15 ft Power Cable and Ground Clamp
- Dual Voltage: 120V/240V

FORNEY SPOOL GUNS

**FNY 85620^{DS} FORNEY® SPOOL PRO
HORNET SG250**

Was ~~\$1004.00~~
Now \$899.00



- Weld Longer and Out of Position
- MAX Output 300 AMPs
- Duty Cycle: 220 Amp @ 60%
- 14H Series TWECO style

**FNY 85650^{DS} FORNEY® 250 AMP
SPOOL GUN**

Was ~~\$604.00~~
Now \$499.00



- Simple and Reliable
- MAX Output: 250 Amps
- Duty Cycle: 200 Amps @ 60%
- 14H Series TWECO Style

**FOR
ALUMINUM
WELDING**

FORNEY PRO HELMETS

**FNY 55935 FORNEY PRO MATTE
BLACK ADF WELDING HELMET**

Was ~~\$177.99~~
Now \$124.99



**FNY 55937^{DS} FORNEY PRO
AMPED ADF WELDING HELMET**

Was ~~\$188.99~~
Now \$129.99



- Variable Shades, 4 Arc Sensors, 10.44 sq in View Area
- Pro Headgear Reduces Fatigue

**FNY 55936 FORNEY PRO CAMO
ADF WELDING HELMET**

Was ~~\$188.99~~
Now \$129.99



**FNY 55938 FORNEY PRO WARHAWK
ADF WELDING HELMET**

Was ~~\$188.99~~
Now \$129.99



- Lightweight
- Arc Optics for True Color Technology

**HOT
BUYS**

BINDER CHAIN

**FNY 70397 BINDER CHAIN,
GRADE 70 (G70), 5/16 IN
X 20 FT, 1-EACH**

Was ~~\$114.99~~
Now \$94.99



**FNY 70398^{DS} BINDER CHAIN,
GRADE 70 (G70), 3/8 IN
X 14 FT, 1-EACH**

Was ~~\$114.99~~
Now \$94.99



**FNY 70399 BINDER CHAIN,
GRADE 70 (G70), 3/8 IN
X 20 FT, 1-EACH**

Was ~~\$148.99~~
Now \$109.99



- DOT Approved G70 with Clevis Grab Hooks
- WLL: 6,600 lbs.

**HOT
BUYS**

WELDING WIRE

**FNY 42291 ER70S-6,
MIG WELDING WIRE,
MILD STEEL, .030 IN
DIAMETER X 2 LB**

Was ~~\$15.49~~
Now \$14.99



**FNY 42300 E71T-GS SELF,
STEEL FLUX-CORE
WELDING WIRE,
.030 IN X 2 LB**

Was ~~\$25.99~~
Now \$22.99



**FNY 42302 E71T-GS SELF,
STEEL FLUX-CORE
WELDING WIRE,
.035 IN X 2 LB**

Was ~~\$25.99~~
Now \$22.99



Have Tools & Equipment Product Questions? Scan Here





Professional Welding Solutions

Synergic Multi-Mig Systems

250A Double-Pulse Synergic Triple Drive Multi-MIG (240V)
HSA HSW6550^{DS}
\$7445 **\$181** for 60 mos.

- Features 42 synergic, pulse & double-pulse programs for aluminum, mild steel and HSS (MIG brazing)
- Large 7" color LCD display with drop down menu torch pad select
- Three MIG guns and wire feeder drives for steel, aluminum alloy & silicone bronze welding wire
- Dual gas regulators and cylinder supports for mixed & argon gas



200A Multi-MIG Synergic Welder AC/DC Pulse TIG & Arc Electrode
HSA HSW6422^{DS} **\$4520**



- LCD select 16 Synergic MIG programs
- Pulse TIG for steel & aluminum alloys

200A Multi-MIG Synergic Welder DC Pulse TIG & Arc Electrode
HSA HSW642003^{DS} **\$3020**



- LCD select 16 Synergic MIG programs
- Pulse TIG for all steel alloys

220A Spool Gun 20-Ft. Direct-Connect
HSA HSW7020^{DS} **\$363.99**

- Spool gun for steel, aluminum & silicone bronze welding wire
- Direct machine connection for all MIGs (Except HSW6213)



True-Color Auto-Darkening Welding Helmet
HSA HSW7030^{DS} **\$181.89**

- Large 9.27 sq. inch viewing area
- 4-Sensor to 3 amps with 5-pt headgear
- Adjust delay, sense, 4-13DIN & grind mode



Plasma & TIG Systems

40 Amp Plasma Cutter (1/2")
HSA HSW6004^{DS}
\$1629



- Professional 50% duty-cycle CSA/UL
- Compact (18 lbs.) & Flexible (110-240V)

60 Amp Plasma Cutter (3/4")
HSA HSW6006^{DS}
\$2529



- Professional 40% duty-cycle CSA/UL
- Compact (24 lbs.) & Flexible (208-240V)

200 Amp AC/DC Pulse TIG Welder
HSA HSW6321^{DS} **\$2510**



- Select ignition, wave form (4), slope, pulse, frequency, balance control, pre and post gas
- Adjustable pulse welds on thinnest steel or aluminum alloys with foot pedal control

MIG Welding Systems

130 Amp MIG & Flux-Core Welder
HSA HSW6213^{DS}
\$624.99



- Economical MIG welder 115VAC
- Powerful 130A @ 20% duty-cycle

140 Amp MIG/Spool Gun Welder
HSA HSW6214^{DS}
\$810



- Professional MIG welder 115VAC
- Powerful 140A @ 35% duty-cycle
- HSW7020 Spool gun ready (ER, AL & ERCuSi)

200 Amp MIG/Spool Gun Welder
HSA HSW6220^{DS}
\$1120



- Professional MIG welder 230VAC
- Powerful 200A @ 35% duty-cycle
- HSW7020 Spool gun ready (ER, AL & ERCuSi)



Paint & Body Solutions

Stud Welding Systems

DualPro Aluminum & Steel Multifunction Dent System
HSA UNI9802^{DS} **\$2710**



Cart Available

AutoPro Steel Multifunction Dent Pulling System
HSA UNI9500^{DS} **\$1060**



Cart Available

Dual-Spotter Aluminum & Steel Stud Gun Kit
HSA UNI9700^{DS}
\$1899



Uni-Spotter Steel Stud Gun Professional "Starter" Kit
HSA UNI4550^{DS} **\$288.99**



Riveting & Panel Repair

Pull-Pro Portable Dent Pulling Tower
HSA UNI1096^{DS}
\$2000



- Dent pulling tower with 1500# capacity
- Single or double air suction plates
- Height extension available

Nitro-Weld Nitrogen & Hot Staple Plastic Repair System
HSA UNI8100^{DS}
\$1660



- Portable system for all plastic repairs.
- Internal compressor
- N² cylinder included
- Hot gas & hot staple torches

SPR-Pro 9-Ton Self-Piercing Riveter
HSA UNI6800^{DS} **\$9000**



Shown with optional blind rivet adapter

Uni-Staple Hot Staple Kit
HSA UNI8000
\$263.99



Uni-Bar Headlight/Taillight Tool Set
HSA UNI7800^{DS} **\$32.99**

*DS = Special Order Item. Contact NAPA representative for lead time



While Supplies Last

25% OFF



Was ~~\$182⁹⁹~~
Now \$137⁹⁹
Carlyle® Wire Frame Creeper
 CHT 8151352

20% OFF



Was ~~\$124⁹⁹~~
Now \$99⁹⁹
Carlyle® Folding Stool w/ Cup Holder
 CHT 8151342

26% OFF



Was ~~\$268⁹⁹~~
Now \$199⁹⁹
Carlyle® Creeper w/ Parts Tray
 CHT 8151341

47% OFF



Was ~~\$227⁹⁹~~
Now \$119⁹⁹
Carlyle® Car Creeper Interior
 CHT 8151337

30% OFF



Was ~~\$265⁹⁹~~
Now \$186¹⁹
Carlyle® 1/2" Drive Extra Long Teardrop Ratchet
 25" Length
 CHT R12XL48

19% OFF



Was ~~\$293⁹⁹~~
Now \$239
Carlyle® 12pc Metric Flat Ratcheting Wrench Set
 8mm-19 mm Wrenches
 CHT RW612M

25% OFF



Was ~~\$312⁹⁹~~
Now \$234⁹⁹
Carlyle® Tool Convertible Creeper Seat
 CHT 8151353

UP TO 50% OFF



Wilton SHOP VISE W/SWIVEL

JET 63300	WS4 4 SHOP VISE W/SWIVEL	Was \$279	Now \$139
JET 63301	WS5 5 SHOP VISE W/SWIVEL	Was \$334	Now \$169
JET 63302	WS6 6 SHOP VISE W/SWIVEL	Was \$484	Now \$245
JET 63304	WS8 8 SHOP VISE W/SWIVEL	Was \$729	Now \$365

44% OFF



Was ~~\$152⁹⁹~~
Now \$85⁹⁹
V20 Cordless Brushless 1/2" Drill/Driver Kit 2 Batteries
 CTM CMCD710C2

34% OFF



Was ~~\$34⁹⁹~~
Now \$22⁹⁹
Turbo Torch TP-10 Pencil Flame Propane Torch
 FPW 03860860

48% OFF



Was ~~\$177⁹⁹~~
Now \$91⁹⁹
V20 MAX Variable Speed Cordless Reciprocating Saw
 Included and Battery Included
 CTM CMCS300M1

25% OFF



Was ~~\$118⁹⁹~~
Now \$89
Firepower Auto-Darkening Welding Helmets
 FPW 14410088



REAL DEALS

FINANCING MADE FOR TECHNICIANS



6 MONTHS PROMOTIONAL FINANCING
on purchases of \$199—or more
with the NAPA Credit Card.*



Scan the QR code to apply directly on your device or see if you prequalify for a new NAPA Credit Card account.

*Subject to credit approval. Minimum monthly payments required. See associate for details. Gas station purchases are not eligible for Promotional Financing.

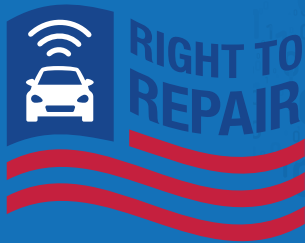

IT'S TIME TO TAKE A STAND.

Support right to repair at repairact.com.

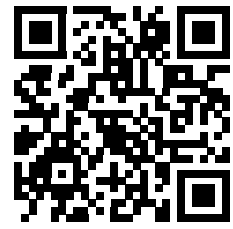

Automakers are making it harder for you to fairly access the tools and data needed to repair and maintain vehicles.

COOL BOSS™ Portable Evaporative Coolers & Industrial Ceiling Fans

By BendPak



CoolBlast SERIES

\$116 for 24 mos. Was **\$2200**
Now **\$2114**

CB-16
BPK 5150151^{DS}
• 60° Gal. Capacity
• 5,845 CFM

\$115 for 36 mos. Was **\$3010**
Now **\$2940**

CB-28
BPK 5150152^{DS}
• 80 Gal. Capacity
• 10,645 CFM

Was **\$4250**
Now **\$4080**

CB-36 **\$112** for 60 mos.
BPK 5150153^{DS}
• 115 Gal. Capacity
• 14,890 CFM

**Industry Leading Tank Capacities
Keep You Cooler, Longer**

© 2024 CoolBoss. All rights reserved.
CoolBoss is a registered trademark of BendPak.

HVLS SERIES

Was **\$3500** **\$106** for 48 mos.
Now **\$3320**

CB11HVLS
BPK 5150201^{DS}
• 11.5 ft. Fan Diameter
• 148,321 CFM

Was **\$5180** **\$136** for 60 mos.
Now **\$4935**

CB20HVLS
BPK 5150237^{DS}
• 20 ft. Fan Diameter
• 448,496 CFM

Was **\$4150** **\$110** for 60 mos.
Now **\$3985**

CB16HVLS
BPK 5150202^{DS}
• 16.5 ft. Fan Diameter
• 360,210 CFM

Was **\$5310** **\$124** for 60 mos.
Now **\$5125**

CB24HVLS
BPK 5150238^{DS}
• 24 ft. Fan Diameter
• 524,422 CFM



**GEARLESS
PMSM**

**Maximize Airflow
While Minimizing Costs**



CoolBreeze SERIES

\$124 for 12 mos. Was **\$1290**
Now **\$1235**

CB-12
BPK 5150018^{DS}
• 15 Gal. Capacity
• 1,850 CFM

\$146 for 12 mos. Was **\$1530**
Now **\$1449**

CB-14
BPK 5150030^{DS}
• 15.6 Gal. Capacity
• 2,715 CFM

Was **\$1840**
Now **\$1781**

CB-26
BPK 5150026^{DS}
• 50 Gal. Capacity
• 7,115 CFM

**Full Featured Cooling
For Any Space**

NAPA MERCHANDISE POLICY

Regular prices shown are manufacturer's suggested retail prices at time of printing. We reserve the right to limit quantities and to correct pricing errors. Some new items might not be available at the time of print deadline. Contact your local NAPA AUTO PARTS store for pricing and availability. Program good at participating locations only. The Commodore Financial Equipment Financing Program is available to businesses only. See your participating NAPA AUTO PARTS store for details, or visit www.CommodoreFinancial.com. Qualifications subject to credit approval. Applicable taxes to be added. Monthly payment estimates reflect "NO MONEY DOWN and 30 DAYS NO PAYMENTS" with a \$1 buyout at agreement end. Terms, conditions and prices vary for businesses less than 3 years old. Terms, conditions and prices vary in Arkansas. Additional freight charges may be required for shipments to Hawaii and Alaska. Some items may have to be special ordered from Hawaii and Alaska Distribution Centers. Prices may vary in Alaska, Hawaii and Mexico. Other restrictions may apply. Some chemicals not available in California. © COPYRIGHT 2023 NATIONAL AUTOMOTIVE PARTS ASSOCIATION. ALL RIGHTS RESERVED.